

# **Gocycle<sup>®</sup> G4**

## **Owner's Manual EN - All Gocycle Models**

August 2024

Pages 2-39

and

## **Product Manual EN - Gocycle G4i**

August 2024

Pages 40-126



# Gocycle Owner's Manual

## IMPORTANT:

This manual contains important safety, performance and service information. Read it before you take the first ride on your new Gocycle, and keep it for reference.

Additional safety, performance and service information for specific components such as suspension or pedals on your Gocycle, or for accessories such as helmets or lights that you purchase, or other accessories or modes of operation may also be available. Make sure that your Gocycle dealer has given you all the manufacturers' literature that was included with your Gocycle or accessories. In case of a conflict between the instructions in this manual and information provided by Gocycle or the component manufacturer, always follow Gocycle over the component manufacturer's instructions.

**WARNING: Before reading this manual, you must visit [www.gocycle.com/safety](http://www.gocycle.com/safety) to check if there are any newer versions of this manual or if there are any Technical Bulletins relevant to your Gocycle model.**

There may be new updates to this manual with important safety related information. Please ensure that you visit [www.gocycle.com/safety](http://www.gocycle.com/safety) to download the latest owner's manual for your product as well as reading and understanding all Technical Bulletins relating to your Gocycle and frame number. You should always use the GocycleConnect App to configure your Gocycle before your first ride or ask your Gocycle dealer to configure your Gocycle for you and convey all of the important safety information contained in the App.

If you have any questions or do not understand something, take responsibility for your safety and consult with your Gocycle dealer or Gocycle.

**NOTE: This manual is not intended as a comprehensive use, service, repair or maintenance manual or a manual on how to fit accessories. Please see your Gocycle dealer for all service, repairs or maintenance. Your Gocycle dealer may also be able to refer you to classes, clinics or books on Gocycle use, service, repair or maintenance. If you have purchased your Gocycle directly from Gocycle, please contact us through [gocycle.com/support](http://gocycle.com/support) for assistance.**

The responsibility for providing support to you and your Gocycle lies with the party that sold you the Gocycle. This is only ever an approved Gocycle dealer or Gocycle. Approved Gocycle dealers can be found on the Gocycle dealer locator on [www.gocycle.com](http://www.gocycle.com). If you require assistance for service, maintenance, or warranty repair, your first contact should be with the party that sold you the Gocycle. Gocycle can provide assistance to all Gocycle owners. However, Gocycle may require you to seek service only from the party that sold you the Gocycle.



# 1 CONTENTS

- 1 Contents .....2**
- 2 Setup, Configuration, and Getting Started.....5**
  - 2.1 Setup ..... 5
  - 2.2 Labelling for USA Type 1 & Type 2 Configuration ..... 6
  - 2.3 Overview and Terminology ..... 7
  - 2.4 Pre-Ride Checks ..... 8
  - 2.5 Bike Fit and Adjustment ..... 10
  - 2.6 Safety First..... 11
  - 2.7 Mechanical Safety Check ..... 11
  - 2.8 First Ride ..... 13
- 3 Safety .....14**
  - 3.1 The Basics ..... 14
  - 3.2 Riding Safety..... 15
  - 3.3 Stopping the Gocycle..... 16
  - 3.4 Riding in Wet, Cold or Icy Conditions..... 16
  - 3.5 Night Riding ..... 17
  - 3.6 Riding in Low Light Conditions ..... 18
- 4 Charging Your Gocycle .....18**
  - 4.1 How to Charge your Gocycle ..... 18
  - 4.2 Important Information: Lithium-Ion Batteries..... 19
- 5 Understanding Your Gocycle .....20**
  - 5.1 Quick Release Pitstopwheels..... 20
  - 5.2 Folding Frame and Handlebar Latches..... 21
  - 5.3 Brake Controls and Features ..... 22
  - 5.4 Shifting gears ..... 23
  - 5.5 Pedals..... 23
  - 5.6 Tires and Tubes ..... 23
- 6 Service.....25**
- 7 Appendix.....28**
  - 7.1 Intended Use..... 28
  - 7.2 Modifications and Refinishing ..... 28
  - 7.3 Maximum Weight Design Limit ..... 29



7.4 The lifespan of your Gocycle and its components..... 30

7.5 Fastener Torque Specifications..... 35

7.6 Warranty, Limitations, & Contact..... 36





## GENERAL WARNING:

Like any sport, bicycling involves risk of injury and damage. By choosing to ride a Gocycle, you assume the responsibility for that risk, so you need to know — and to practice — the rules of safe and responsible riding and of proper use and maintenance. Proper use and maintenance of your Gocycle reduces risk of injury.

Warning: Riding any bicycle involves the risk of product damage, serious injury or even death. Such risks are increased in busy, urban environments with moving traffic. By choosing to ride a Gocycle, you assume the responsibility for these risks, and it is important that you know how to ride responsibly and to exercise proper maintenance to minimise such risks and potential damage. Do not try to ride beyond the limits of your ability or the limits of the Gocycle.

This Manual contains many “Warnings” and “Cautions” concerning the consequences of failure to maintain or inspect your Gocycle and of failure to follow safe cycling practices.

The combination of the  safety alert symbol and the word **WARNING** indicates a potentially hazardous situation which, if not avoided, could result in serious injury or death.

The combination of the  safety alert symbol and the word **CAUTION** indicates a potentially hazardous situation which, if not avoided, may result in minor or moderate injury, or is an alert against unsafe practices.

The word **CAUTION** used without the safety alert symbol indicates a situation which, if not avoided, could result in serious damage to the Gocycle or the voiding of your warranty.

Many of the Warnings and Cautions say, “You may lose control and fall”. Because any fall can result in serious injury or even death, we do not always repeat the warning of possible injury or death.

Because it is impossible to anticipate every situation or condition that can occur while riding, this Manual makes no representation about the safe use of the Gocycle under all conditions. There are risks associated with the use of any Gocycle which cannot be predicted or avoided, and which are the sole responsibility of the rider.

We strongly recommend that you learn more about the inherent risks associated with riding bicycles and suggest that you:

- Ask your local bike retailer for information or instruction on safe cycling.
- Ride within your means and ability.
- Attend a training session or safe cycling workshop run by many local bike clubs, police departments, schools or government support groups.
- Search “bicycle safety” online for reference information.

Skills of riders can vary; for example, it takes a highly skilled rider to travel at high speeds and/or close to obstacles, cars or other cyclists. Do not ride in a manner that exceeds the limits of your ability.



## 2 SETUP, CONFIGURATION, AND GETTING STARTED

NOTE: We strongly urge you to read this manual in its entirety before your first ride. At the very least, read and make sure that you understand each point in this section, and refer to the cited sections on any issue that you don't completely understand. Please note that not all Gocycles have all of the features described in this Manual. Ask your Gocycle dealer to point out the features of your Gocycle or contact Gocycle if you have purchased your Gocycle from Gocycle.

### 2.1 Setup

 | No compromises



1. Download **gocycleconnect** app
2. Open the app and press 'SETUP'
3. Follow and complete all steps

Support

  
[gocycle.com/support](http://gocycle.com/support)  
[gocycle.com/support](http://gocycle.com/support)  
Owner's manuals  
  
[gocycle.com/safety](http://gocycle.com/safety)  
[gocycle.com/safety](http://gocycle.com/safety)

Accessory Videos

  
[gocycle.com/support](http://gocycle.com/support)  
[gocycle.com/support](http://gocycle.com/support)  
Email  
  
[customerservice@gocycle.com](mailto:customerservice@gocycle.com)



**WARNING:** Ensure that your Gocycle dealer has configured and labelled your Gocycle appropriately for your region of operation. If you are configuring your Gocycle with the GocycleConnect App, ensure that you are an authorised person authorised to configure the Gocycle to the region of operation.



## 2.2 Labelling for USA Type 1 & Type 2 Configuration

**IMPORTANT INFORMATION:  
How to label for US Type 1 or Type 2 Ebike**

**Gocycles configured as US Type 1 or Type 2 Ebikes must be labelled appropriately as below:**

<p><b>US Type 1</b></p> <ul style="list-style-type: none"> <li>- Maximum speed of 20 miles per hour</li> <li>- Pedal only activation of motor</li> </ul>	<p><b>US Type 2</b></p> <ul style="list-style-type: none"> <li>- Maximum speed of 20 miles per hour</li> <li>- Pedal or throttle activation of motor</li> </ul>
--	---

EN 14764 EN 15194  
**US Type 1**  
 20 mph **CE**  
 500W

EN 14764 EN 15194  
**US Type 2**  
 20 mph **CE**  
 500W

Affix appropriate label as shown below:

Before riding your Gocycle, visit  
www.gocycle.com/safety  
**360101**  
  
EN 14764  
EPAC  
According to EN 15194  
25 KM/h  
250 W **CE**  
Compatible with Gocycle G2 & G3 second & third generation. 48V lithium charger only.  
Designed by Karbon Kinetics in London Assembled in Poland  
UK Reg No. 4357956

EN 14764 EN 15194  
**US Type 1**  
 20 mph **CE**  
 500W

Before riding your Gocycle, visit  
www.gocycle.com/safety  
**360101**  
  
EN 14764  
EPAC  
According to  
25 KM/h  
250 W **CE**  
Compatible with Gocycle G2 & G3 second & third generation. 48V lithium charger only.  
Designed by Karbon Kinetics in London Assembled in Poland  
UK Reg No. 4357956

EN 14764 EN 15194  
**US Type 1**  
 20 mph **CE**  
 500W

Before riding your Gocycle, visit  
www.gocycle.com/safety  
**360101**  
  
EN 14764 EN 15194  
US Type 1  
20 mph **CE**  
500W  
Compatible with Gocycle G2 & G3 second & third generation. 48V lithium charger only.  
Designed by Karbon Kinetics in London Assembled in Poland  
UK Reg No. 4357956

Additional sets of US Type 1 & 2 labels are available for purchase at [www.gocycleusa.com](http://www.gocycleusa.com).

*Description: US Type 1 & 2 Set*  
*Product Code: KKL-2885-3502-01*



### 2.3 Overview and Terminology

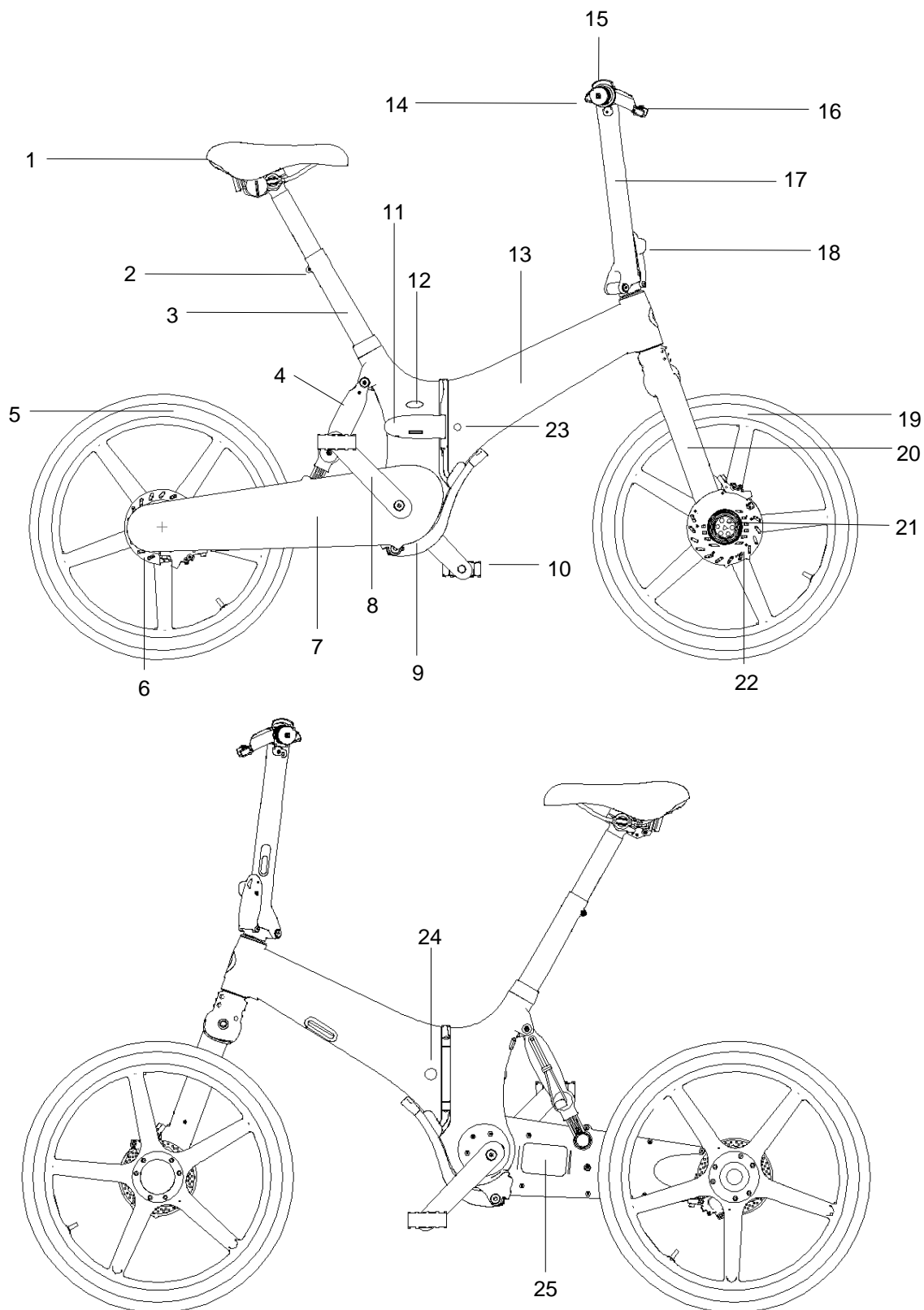





- |                           |                             |
|---------------------------|-----------------------------|
| 1. Saddle                 | 14. Grips                   |
| 2. Upper Seat Post Clamp  | 15. Shifter                 |
| 3. Seat Post              | 16. Brake Lever             |
| 4. Lockshock              | 17. Stem                    |
| 5. Rear Pitstopwheel®     | 18. Stem Latch              |
| 6. Rear Disk Rotor        | 19. Front Pitstopwheel®     |
| 7. Cleandrive®            | 20. Fork                    |
| 8. Cranks                 | 21. Motor                   |
| 9. Kickstand              | 22. Front Disk Rotor        |
| 10. Pedal                 | 23. Charging Port           |
| 11. Frame Latch           | 24. Battery On / Off Button |
| 12. Frame Seat Post Clamp | 25. Serial Number           |
| 13. Frame                 |                             |

## 2.4 Pre-Ride Checks

NOTE: Correct fit is an essential element of bicycling safety, performance and comfort. Making the adjustments to your Gocycle that result in correct fit for your body and riding conditions requires experience, skill and special tools. Always have your Gocycle dealer make the adjustments on your Gocycle; or, if you have the experience, skill and tools, have your Gocycle dealer check your work before riding. **We strongly recommend that you use the GocycleConnect App to complete the Pre-ride Checks.**



**WARNING: If your Gocycle does not fit you properly, you may lose control and fall. If your new bike doesn't fit you, do not ride it.**

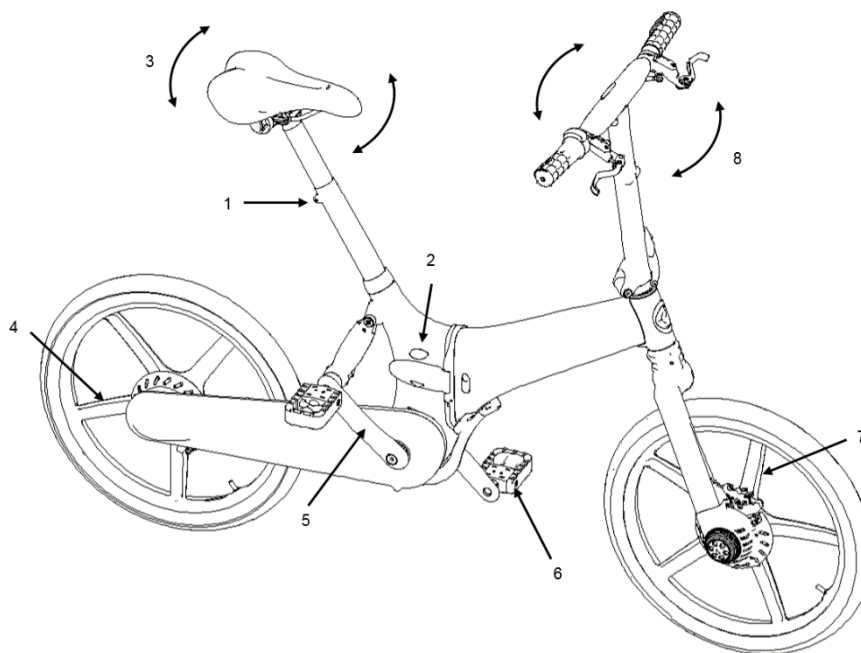

1. Check for loose joints: 1. Uppers seat post clamp 5-7 Nm. 2. Frame seat post clamp 5-7 Nm. 3. Seat post does not twist. 4. Rear wheel. 5. Crank arms. 6. Pedals. 7. Front wheel. 8. Handlebar cannot twist from fork. Check that there are no missing bolts, nuts or fasteners.

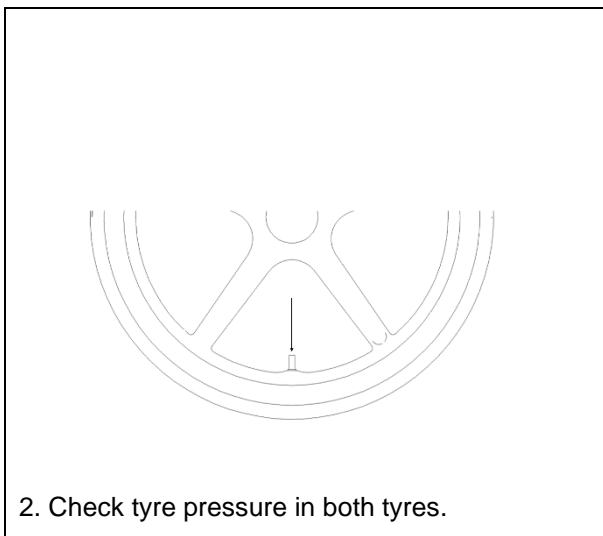

2. Check tyre pressure in both tyres.

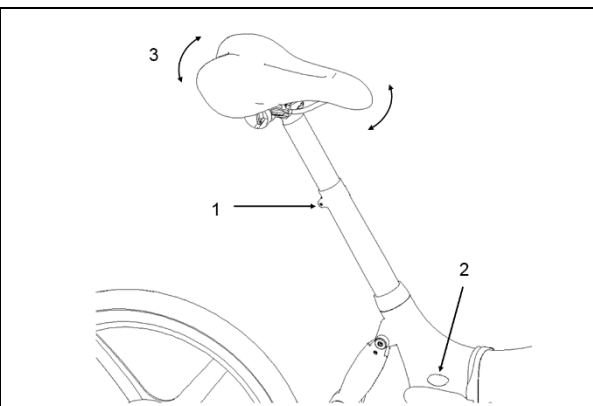

3. Check seat post. 1. Upper seat post clamp: 5-7 Nm. 2. Frame seat post clamp: 5-7 Nm. 3. Seat does not twist. Ensure that when you are sitting on the saddle comfortably, you can touch both feet on the ground.

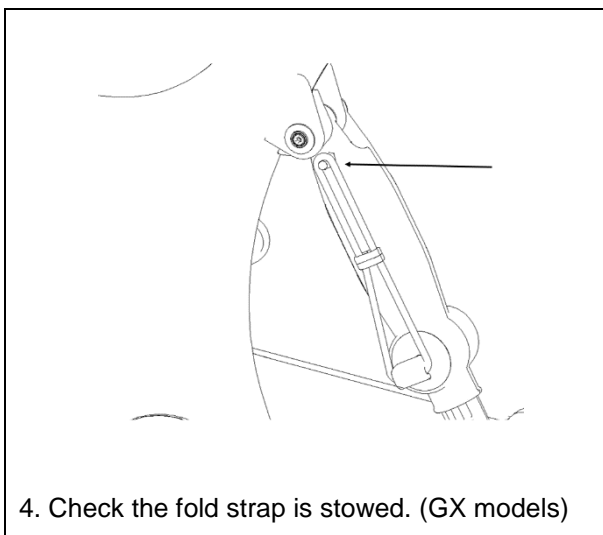

4. Check the fold strap is stowed. (GX models)

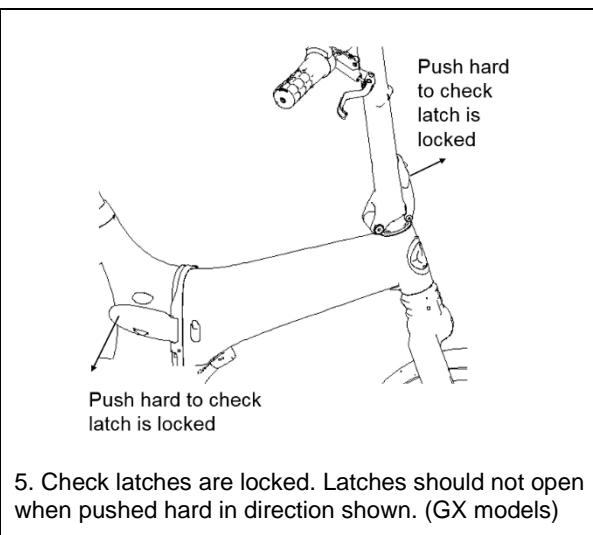

5. Check latches are locked. Latches should not open when pushed hard in direction shown. (GX models)

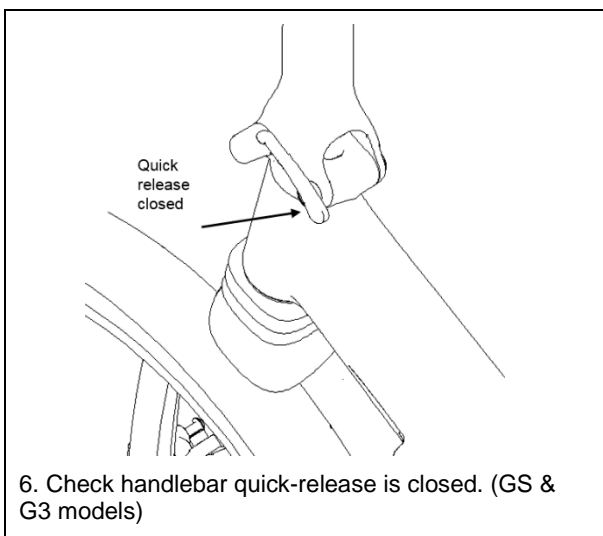

6. Check handlebar quick-release is closed. (GS & G3 models)

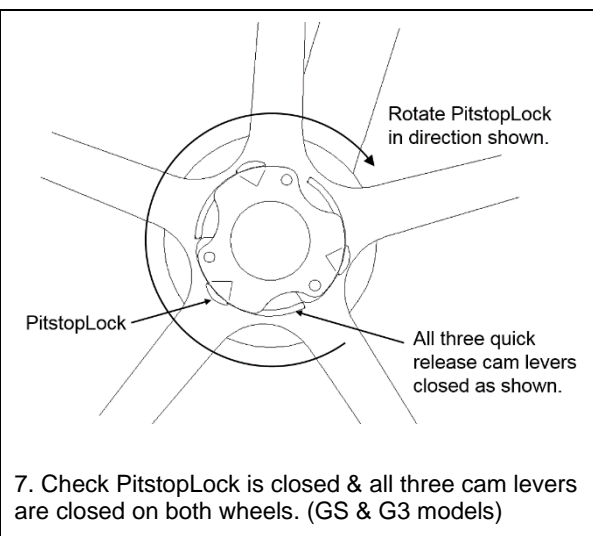

7. Check PitstopLock is closed & all three cam levers are closed on both wheels. (GS & G3 models)

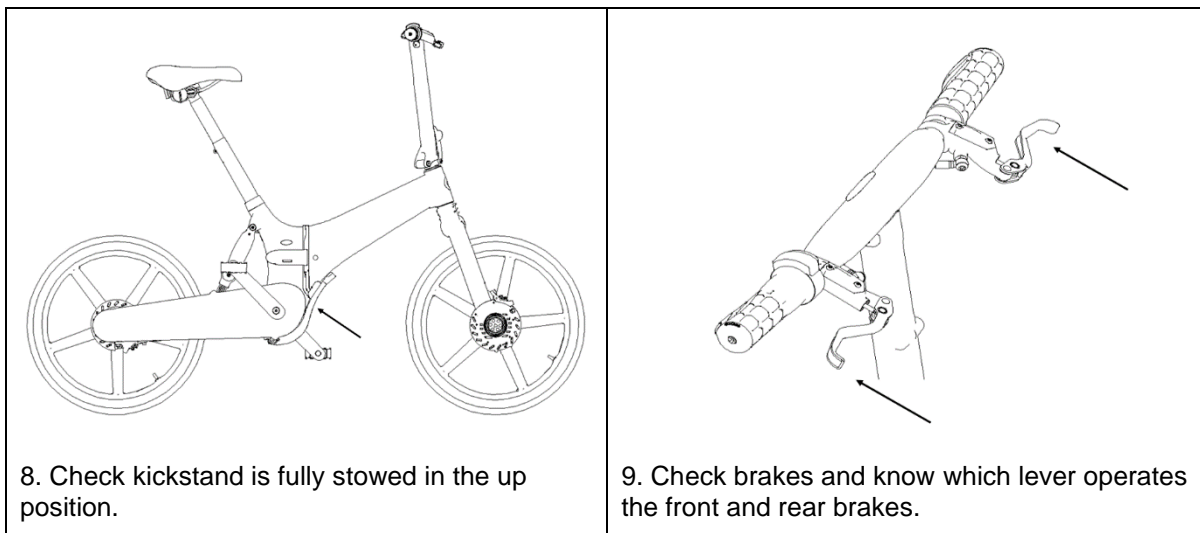

8. Check kickstand is fully stowed in the up position.

9. Check brakes and know which lever operates the front and rear brakes.

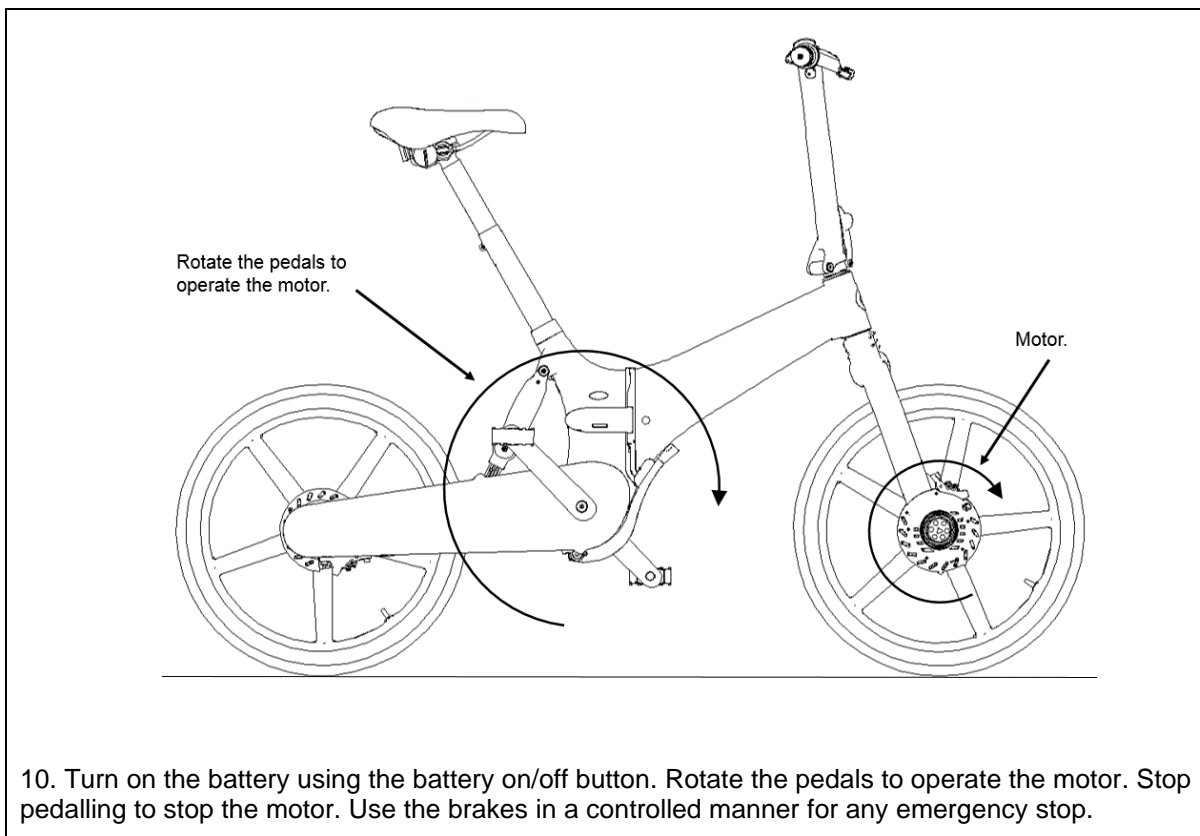

10. Turn on the battery using the battery on/off button. Rotate the pedals to operate the motor. Stop pedalling to stop the motor. Use the brakes in a controlled manner for any emergency stop.

## 2.5 Bike Fit and Adjustment

- Is the saddle at the right height?. Make sure the saddle height is adjusted so that you can touch the ground with both feet whilst seated on the saddle. This may mean that you are touching the ground on your tip toes. If you are a less experienced rider, start out with the saddle adjusted so that you can comfortable have both feet on the ground whilst seated on the saddle.

**⚠ WARNING: If your seat post is not inserted in the seat tube so that the minimum insertion mark on the seat post is hidden, the seat post, binder or even frame may break, which could cause you to lose control and fall.**



- Are the saddle and seat post securely clamped? A correctly tightened saddle will allow no saddle movement in any direction.
- Are the stem and handlebars at the right height for you? Some Gocycles are equipped with an adjustable angle stem. If your Gocycle has an adjustable angle stem, ask your Gocycle dealer or Gocycle to show you how to adjust it. Note: changing stem angle may also require adjustments to the Gocycle's controls such as the brake levers and Gocycle front fork alignment.



**WARNING: Always tighten fasteners to the correct torque. Bolts that are too tight can stretch and deform. Bolts that are too loose can move and fatigue. Either mistake can lead to a sudden failure of the bolt, causing you to lose control and fall.**



**WARNING: An insufficiently tightened fork clamp bolt may compromise steering action, which could cause you to lose control and fall. Place the front wheel of the Gocycle between your legs and attempt to twist the handlebar/stem assembly. If you can twist the stem in relation to the front wheel, turn the handlebars in relation to the stem, the bolts are insufficiently tightened.**

- Can you comfortably operate the brakes? The angle of the brake and shift control levers and their position on the handlebars can be changed. Ask your Gocycle dealer or Gocycle to make the adjustments for you. If you choose to make your own control lever angle adjustment, be sure to re-tighten the clamp fasteners to the recommended torque found in the Appendix.
- The Gocycle's brake levers can be adjusted for reach. If you have small hands or find it difficult to squeeze the brake levers, contact your Gocycle dealer or Gocycle to assist with adjusting the reach of the brake levers.



**WARNING: The shorter the brake lever reach, the more critical it is to have correctly adjusted brakes, so that full braking power can be applied within available brake lever travel. Brake lever travel insufficient to apply full braking power can result in loss of control, which may result in serious injury or death.**

- Do you fully understand how to operate your new Gocycle? If not, before your first ride, have your Gocycle dealer explain any functions or features that you do not understand or contact Gocycle for further assistance.
- Do you feel fully comfortable and in control of the Gocycle whilst seated holding the handlebars and operating the brake levers. If you are in doubt of your ability to safely control the Gocycle, ask your Gocycle dealer or Gocycle for assistance.

## 2.6 Safety First

- Always wear an approved helmet when riding your bike, and follow the helmet manufacturer's instructions for fit, use and care.
- Do you have all the other required and recommended safety equipment? See Section 3. It's your responsibility to familiarize yourself with the laws of the areas where you ride, and to comply with all applicable laws.
- Do you know how to correctly secure your front and rear wheels? Check Section 5 to make sure. Riding with an improperly secured wheel can cause the wheel to wobble or disengage from the Gocycle, and cause serious injury or death.

## 2.7 Mechanical Safety Check

- Routinely check the condition of your Gocycle before every ride.
- Nuts, bolts screws & other fasteners: Because there are a wide variety of fastener sizes and shapes made in a variety of materials, often differing by model and



component, the correct tightening force or torque cannot be generalized. To make sure that the many fasteners on your Gocycle are correctly tightened, refer to the Fastener Torque Specifications in the Appendix of this manual or to the torque specifications in the instructions provided by the manufacturer of the component in question. Correctly tightening a fastener requires a calibrated torque wrench. A professional bicycle mechanic with a torque wrench should torque the fasteners on your Gocycle. If you choose to work on your own Gocycle, you must use a torque wrench and the correct tightening torque specifications from the Gocycle or component manufacturer or from your Gocycle dealer. If you need to make an adjustment at home or in the field, we urge you to exercise care, and to have the fasteners you worked on checked by your Gocycle dealer or a qualified bicycle mechanic as soon as possible. Note that there are some components that require special tools and knowledge. In Section 2, 3, 4, and 5 we discuss the items that you may be able to adjust yourself. All other adjustments and repairs should be done by a qualified Gocycle mechanic.



**WARNING: Correct tightening force on fasteners – nuts, bolts, screws – on your Gocycle is important. Too little force, and the fastener may not hold securely. Too much force, and the fastener can strip threads, stretch, deform or break. Either way, incorrect tightening force can result in component failure, which can cause you to lose control and fall.**

- Make sure nothing is loose. Do a visual and tactile inspection of the whole bike. Any loose parts or accessories? If so, secure them. If you're not sure, ask someone with experience to check.
- Tires & Wheels: Make sure tires are correctly inflated as per section 5. Check by putting one hand on the saddle, one on the intersection of the handlebars and stem, then bouncing your weight on the bike while looking at tire deflection. Compare what you see with how it looks when you know the tires are correctly inflated; and adjust if necessary.
- Tires in good shape? Spin each wheel slowly and look for cuts in the tread and sidewall. Replace damaged tires before riding the bike.
- Wheels rims undamaged? Check the rim of the wheel. So you see any cracks around where the spokes meet the rim? Do you see any paint discoloration or flaking of paint that could be a crack? If you notice cracks, don't ride your Gocycle and consult with your Gocycle dealer or Gocycle directly.



**WARNING: Gocycle wheel rims are subject to wear. Riding a wheel that is at the end of its usable life can result in wheel failure, which can cause you to lose control and fall.**

- Brakes: Check the brakes for proper operation (see Section 5). Squeeze the brake levers. Can you apply full braking force at the levers without having them touch the handlebar? If not, your brakes need adjustment. Do not ride the bike until the brakes are properly adjusted by a professional bicycle mechanic.
- Wheel retention system: If your Gocycle has quick release wheels, make sure the front and rear wheels are correctly secured. See Section 5.
- Seat post: Check that it is properly adjusted and cannot twist or move up or down under your weight. See Section 5.
- Handlebar and saddle alignment: Make sure the saddle and handlebar stem are parallel to the bike's centre line and clamped tight enough so that you can't twist them out of alignment. See Sections 2.
- Handlebar ends: Make sure the handlebar grips are secure and in good condition, with no cuts, tears, or worn out areas. If not, replace them. Make sure the handlebar ends and extensions are plugged. If not, plug them before you ride.



**⚠ WARNING: Loose or damaged handlebar grips or extensions can cause you to lose control and fall. Unplugged handlebars or extensions can cut you and cause serious injury in an otherwise minor accident.**

**⚠ WARNING: Please also read and become thoroughly familiar with the important information on the lifespan of your Gocycle and its components in the Appendix.**

## 2.8 First Ride

When you buckle on your helmet and go for your first familiarization ride on your new Gocycle, be sure to pick a controlled environment, away from cars, other cyclists, obstacles or other hazards. Ride to become familiar with the controls, features and performance of your new Gocycle.

Familiarize yourself with the braking action of the Gocycle (see Section 5). Test the brakes at slow speed, putting your weight toward the rear and gently applying the brakes, rear brake first. Sudden or excessive application of the front brake could pitch you over the handlebars. Applying brakes too hard can lock up a wheel, which could cause you to lose control and fall. Skidding is an example of what can happen when a wheel locks up.

Practice shifting the gears (see Section 5). Check out the handling and response of the Gocycle; and check the comfort.

If you have any questions, or if you feel anything about the Gocycle is not as it should be, consult your Gocycle dealer or Gocycle before you ride again.

### 2.8.1 Riding Modes

You can operate your Gocycle in different pre-set modes or generate a custom mode to suit your personal riding style with the GocycleConnect App. City mode is the default configuration when your Gocycle is first set up.

Mode Name	How to Start Motor	How to Stop Motor	Continuously Press and hold the boost button to Operate the Motor	Pedal Input Controls Motor Power	Press and hold the boost button for Full Motor Assist	Low Battery Warning (G2 & G3 only 1 LED Flashing)
City	Light pedal effort	Stop pedalling or reduce pedal effort	X	√	√	Motor will not operate unless boost button is pressed
Eco	Medium pedal effort	Stop pedalling or reduce pedal effort	X	√	√	Motor will not operate unless boost button is pressed
On Demand	Pedal + rotate selector A "wrist down"	Stop pedalling or release selector	√	X	√	Motor will not operate unless boost button is pressed
Custom	Customisable via App (see <a href="http://www.gocycle.com/support">www.gocycle.com/support</a> for more information)					

**⚠ WARNING! Make sure you understand how you have configured your Gocycle and which mode you have set your Gocycle to operate. It is your responsibility to know and understand how you have configured your Gocycle. Make sure you explain this and all important safety points to any other user you may offer a test ride too.**

**⚠ WARNING! The Gocycle electric drive will change your normal speed envelope. For a similar effort that you are used to with riding a bicycle, you will travel faster! You will catch up to other road users in front of you more easily and this may surprise you. Be prepared to use the brakes and apply safe braking technique. Take time to get used to this new speed envelope on quiet roads before venturing out into busier traffic.**



**⚠ WARNING! First familiarise yourself with the modes of operation, controls and performance of your Gocycle before venturing onto busy streets.**

We strongly recommend that you familiarise yourself with your new Gocycle by first riding it in a controlled environment, away from potential hazards such as moving traffic and obstacles. It is important to become familiar with the modes of operation, controls, brakes and the different performance characteristics inherent in the electric motor.

**⚠ WARNING! Your braking efficiency will increase during the first few rides as your brake disks and pads “bed in”. To accelerate the increase in braking performance, perform a number of controlled stops under hard braking.**

**⚠ WARNING! Please ensure that you visit [www.gocycle.com/safety](http://www.gocycle.com/safety) at least once every three months to check if there are any Technical Bulletins relating to your model and frame number. Having your contact email as the main registered email with the GocycleConnect App is strongly advised. If we ever need to contact you about an important safety or service issue, we will do this by email to the email address that you registered with on the GocycleConnect App. Make sure you add Gocycle.com to your safe sender list.**

## 3 SAFETY

### 3.1 The Basics

**⚠ WARNING: The area in which you ride may require specific safety devices. It is your responsibility to familiarize yourself with the laws of the area where you ride and to comply with all applicable laws, including properly equipping yourself and your bike as the law requires.**

Observe all local bicycle and electric bicycle laws and regulations. Observe regulations about bicycle and electric bicycle lighting, licensing of bicycle and electric bicycle, riding on sidewalks, laws regulating bike path and trail use, helmet laws, child carrier laws, special bicycle and electric bicycle traffic, power, and speed laws, and laws about bicycle and electric bicycle labelling or marking, and insurance requirements for bicycles and electric bicycles. It's your responsibility to know and obey the laws.



1. Always wear a cycling helmet that meets the latest certification standards and is appropriate for the type of riding you do. Always follow the helmet manufacturer's instructions for fit, use and care of your helmet. Most serious bicycle and electric bicycle injuries involve head injuries that might have been avoided if the rider had worn an appropriate helmet.

**⚠ WARNING: Failure to wear a helmet when riding may result in serious injury or death.**

2. Always do the Mechanical Safety Check (Section 2) before you get on the Gocycle.
3. Be thoroughly familiar with the controls of your Gocycle: brakes (Section 5); pedals (Section 5); shifting (Section 5)
4. Be careful to keep body parts and other objects away from the disk brakes, hot motor surface, the turning pedals and cranks, and the spinning wheels of your Gocycle.
5. Always wear:
  - Shoes that will stay on your feet and will grip the pedals. Make sure that shoelaces cannot get into moving parts, and never ride barefoot or in sandals.



- Bright, visible clothing that is not so loose that it can be tangled in the Gocycle or snagged by objects at the side of the road or trail.
  - Protective eyewear, to protect against airborne dirt, dust and bugs — tinted when the sun is bright, clear when it's not.
6. Do not jump with your Gocycle. Jumping a Gocycle like a BMX or mountain bike can put huge and unpredictable stress on the Gocycle and its components. Riders who insist on jumping or repeated riding off curbs, risk serious damage to their Gocycles as well as to themselves.
  7. Ride at a speed appropriate for conditions. Higher speed means higher risk.

## 3.2 Riding Safety

1. Obey all Rules of the Road and all local traffic laws.
2. You are sharing the road or the path with others — motorists, pedestrians and other cyclists. Respect their rights.
3. Ride defensively. Always assume that others do not see you.
4. Look ahead, and be ready to avoid:
  - Vehicles slowing or turning, entering the road or your lane ahead of you, or coming up behind you.
  - Parked car doors opening.
  - Pedestrians stepping out.
  - Children or pets playing near the road.
  - Pot holes, sewer grating, railroad tracks, expansion joints, road or sidewalk construction, debris and other obstructions that could cause you to swerve into traffic, catch your wheel or cause you to have an accident.
  - The many other hazards and distractions which can occur on a Gocycle ride.
5. Ride in designated bike lanes, on designated bike paths or as close to the edge of the road as practicable, in the direction of traffic flow or as directed by local governing laws.
6. Stop at stop signs and traffic lights; slow down and look both ways at street intersections. Remember that a bicycle always loses in a collision with a motor vehicle, so be prepared to yield even if you have the right of way.
7. Use approved hand signals for turning and stopping.
8. Never ride with headphones. They mask traffic sounds and emergency vehicle sirens, distract you from concentrating on what's going on around you, and their wires can tangle in the moving parts of the Gocycle, causing you to lose control.
9. Never carry a passenger. Do not fit a child seat.
10. Never carry anything which obstructs your vision or your complete control of the Gocycle, or which could become entangled in the moving parts of the Gocycle.
11. Never hitch a ride by holding on to another vehicle.
12. Don't do stunts, wheelies or jumps. Think carefully about your skills before deciding to take the large risks that go with this kind of riding.
13. Don't weave through traffic or make any moves that may surprise people with whom you are sharing the road.
14. Observe and yield the right of way.
15. Never ride your Gocycle while under the influence of alcohol or drugs.
16. If possible, avoid riding in bad weather, when visibility is obscured, at dawn, dusk or in the dark, or when extremely tired. Each of these conditions increases the risk of accident.
17. Do not ride the Gocycle off road.





### 3.3 Stopping the Gocycle

The Gocycle is equipped with front and rear hydraulic disk brakes, operated by two levers on the handlebars (shown below). Before riding, it is important to familiarise yourself with which brake lever operates the front brake and which lever operates the rear brake. Proper use of your brakes will slow and bring your Gocycle to a safe and controlled stop.

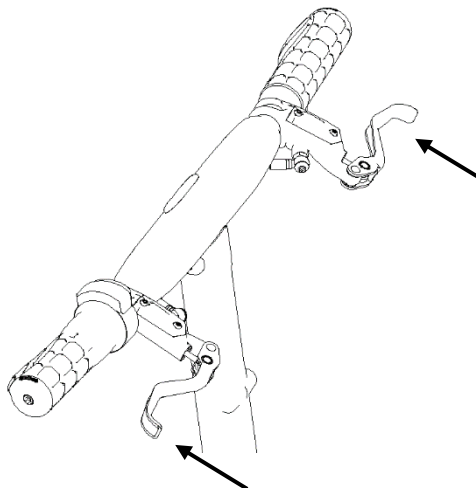

**⚠️ WARNING!** To slow or stop the Gocycle in normal operation, apply the brakes appropriately. In the event that an emergency stop is required, apply the brakes appropriately and in a safe and controlled manner until you have brought the Gocycle to a complete stop. Do not release the brakes until it is safe to do so.

Aggressive use of the brakes may cause your Gocycle to skid, potentially resulting in loss of control. Anticipate your need to stop and slow using appropriate pressure on the brake levers.

### 3.4 Riding in Wet, Cold or Icy Conditions

Under wet, cold or icy conditions, the stopping power of your brakes and tyres (as well as the brakes of other vehicles sharing the road) is dramatically reduced. This makes it harder to control speed and easier to lose control. It also makes skidding during turning more likely. Ride more slowly and cautiously when in wet weather. If it is cold, near or below the temperature when water freezes, be careful of ice on the roads which could be dangerous.

**⚠️ WARNING!** Wet or icy conditions impair traction, braking and visibility, both for the cyclist and for other vehicles sharing the road. The risk of an accident is dramatically increased in wet conditions.

To make sure that you can slow down and stop safely in wet conditions, ride more slowly and apply your brakes more gradually than you would under normal, dry conditions.

We do not recommend riding in heavy rain or standing water, but we do understand that this is not always avoidable. If your Gocycle gets wet, clean and dry it within 15 minutes of heavy wet weather riding.

**⚠️ WARNING:** Wet weather impairs traction, braking and visibility, both for the bicyclist and for other vehicles sharing the road. The risk of an accident is dramatically increased in wet conditions.

Under wet conditions, the stopping power of your brakes (as well as the brakes of other vehicles sharing the road) is dramatically reduced and your tires don't grip nearly as well. This makes it harder to control speed and easier to lose control. To make sure that you can slow down and stop safely in wet conditions, ride more slowly and apply your brakes earlier and more gradually than you would under normal, dry conditions. See also Section 5.



### 3.5 Night Riding

Riding a Gocycle at night is *much* more dangerous than riding during the day. A bicyclist is very difficult for motorists and pedestrians to see. Adults who chose to accept the greatly increased risk of riding at dawn, at dusk or at night need to take extra care both riding and choosing specialized equipment that helps reduce that risk. Consult your Gocycle dealer about night riding safety equipment.



**WARNING: Reflectors are not a substitute for required lights. Riding at dawn, at dusk, at night or at other times of poor visibility without an adequate bicycle lighting system and without reflectors is dangerous and may result in serious injury or death.**

Bicycle reflectors are designed to pick up and reflect car lights and street lights in a way that may help you to be seen and recognized as a moving bicyclist.



**CAUTION: Check reflectors and their mounting brackets regularly to make sure that they are clean, straight, unbroken and securely mounted. Have your Gocycle dealer replace damaged reflectors and straighten or tighten any that are bent or loose.**



**WARNING: Do not remove the front or rear reflectors or reflector brackets from your Gocycle. They are an integral part of the Gocycle's safety system. Removing the reflectors reduces your visibility to others using the roadway. Being struck by other vehicles may result in serious injury or death.**

If you choose to ride under conditions of poor visibility, check and be sure you comply with all local laws about night riding, and take the following strongly recommended additional precautions:

- Purchase and install head and tail lights which meet all regulatory requirements for where you live and provide adequate visibility.
- Wear light coloured, reflective clothing and accessories, such as a reflective vest, reflective arm and leg bands, reflective stripes on your helmet, flashing lights attached to your body and/or your Gocycle ... any reflective device or light source that moves will help you get the attention of approaching motorists, pedestrians and other traffic.
- Make sure your clothing or anything you may be carrying on the Gocycle does not obstruct a reflector or light.
- Make sure that your Gocycle is equipped with correctly positioned and securely mounted reflectors.
- While riding at dawn, at dusk or at night:
  - Ride slowly.
  - Avoid dark areas and areas of heavy or fast-moving traffic.
  - Avoid road hazards.
  - If possible, ride on familiar routes.
  - If riding in traffic:
    - Be predictable. Ride so that drivers can see you and predict your movements.
    - Be alert. Ride defensively and expect the unexpected.
    - If you plan to ride in traffic often, ask your Gocycle dealer about traffic safety classes or a good book on bicycle traffic safety.



## 3.6 Riding in Low Light Conditions

In low light conditions at night, dawn, dusk or during adverse weather conditions such as fog, the visibility of cyclists is dramatically reduced.

**WARNING!** Never ride a bicycle in low light conditions without appropriate front and rear lights fitted and “on” (illuminated) that meet or exceed the national standards of the country in which it is being ridden.

We recommend that you consult the relevant national safety organization or a reputable cycle dealer on what the minimum recommended lighting requirements are in your particular country or region.

- For reference when selecting lights, your Gocycle has a 34.9mm diameter seat post and a 38.5 mm diameter upper handlebar stem. We recommend that you choose a light with a variable length strap mounting system.
- The following are additional recommendations:
- Wear bright, reflective clothing such as reflective vests, leg and arm bands.
- Ensure that your Gocycle is equipped with correctly positioned reflectors (see 4.5 Front and Rear Reflectors).

## 4 CHARGING YOUR GOCYCLE

### 4.1 How to Charge your Gocycle

1. Ensure that your Gocycle is not wet. If it is, wipe down with a cloth or wait until it is dry.
2. Plug the charger into the wall main power socket. Switch on the wall mains power.
3. Open the rubber charging port cover.
4. Insert the charging lead into the charging point of the battery.
5. The charger light will turn orange to indicate charging. Charge time up to 7 hours with Gocycle 2amp charger. For faster charging times the Gocycle Fast Charger is available. Visit [www.gocycle.com](http://www.gocycle.com) for more information.
6. When the battery is fully charged (100% on the GocycleConnect App or 4 LEDs on the battery), remove the charging lead and replace the rubber charging port cover.

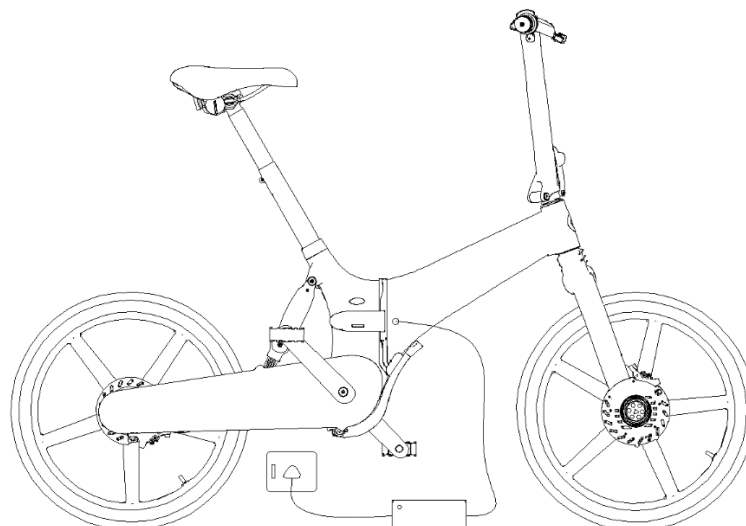

**BEST PRACTICE!** With the battery fully charged and the charger disconnected, turn the battery off. In any event, do not leave the Gocycle plugged in to the charger or on charge continuously for more than 24 hours.



**WARNING: Ensure that the rubber charging port cover is securely in place before riding. Failure to do this could result in your battery being compromised by water and your warranty being invalidated. The following important information applies to your Gocycle lithium battery. Read carefully to ensure the proper and safe operation and storage of the battery.**

## 4.2 Important Information: Lithium-Ion Batteries

The following important information applies to your Gocycle lithium battery. Read carefully to ensure the proper and safe operation and storage of the battery.

- Your battery has been designed for use with Gocycle models only. Do not use the battery with any other product.
- Never charge your battery in a room that does not have an appropriate smoke detector.
- If you are charging your battery in a garage or other storage unit such as a garden shed, boat house, RV, boat, or car, ensure that an appropriate smoke detector is fitted.
- Do not use a used or second hand lithium battery in your Gocycle that has not been approved by Gocycle. When in doubt, contact us through [gocycle.com/support](https://gocycle.com/support).
- Do not handle the battery with wet hands.
- Do not short circuit, disassemble, damage or modify the battery in any way.
- Do not expose the battery to fire or high temperatures over 40°C (104°F).
- Do not drop or subject the battery to strong impacts. Impacts can damage the internal battery safety devices and cause the battery to overheat, ignite, rupture or leak.
- Only use, charge or store the battery in an environment with ambient temperatures between 5°C and 40°C (32°F and 104°F) and a humidity of 45% to 85% RH.
- Do not charge the battery if it is below 5°C (32°F).
- Do not expose the battery to water or moisture. Water can corrode or damage the internal battery safety devices and cause the battery to overheat, ignite, rupture or leak.
- In the event that the Gocycle or battery has been submerged or partially or completely flooded in water, the battery is no longer safe to operate and should be handled with extreme caution. Water can corrode or damage the internal battery safety devices and cause the battery to overheat, ignite, rupture or leak. Do not attempt to charge the battery, turn it on or ride the Gocycle using the battery. The Gocycle should be removed to a safe, well ventilated location away from people, buildings, and combustible materials and monitored from a safe distance for a minimum of 8 hours. In the event that you should detect smoke or fire, call the fire department immediately. After sufficient monitoring and only if it is safe to do so, remove the battery from the Gocycle. Contact your local lithium battery recycling centre to arrange collection and safe disposal.
- Do not keep or store lithium batteries that have been partially or completely flooded or submerged in water.
- Only use the specified charger and charger lead supplied with Gocycle. An inappropriate charger may cause damage or injury through fire or electric shock.
- Check that your insurance policy includes cover for electric bikes.
- Do not leave the battery unattended whilst charging. For example, do not place your Gocycle on charge and leave your properties unattended. Do not be at a distance where you cannot hear the smoke detector where your Gocycle is being charged.



- Make sure you can hear your smoke detector throughout your house. For example, if you charge your Gocycle in your garage or garden shed, make sure you can hear your smoke detector anywhere on your property.
- Lithium batteries do not last forever and could become unstable or compromised over time which could result in increased risk of fire during operation or charging. You will need to recycle your Gocycle lithium battery within 5 years of the date of original purchase as new. Contact your local lithium battery recycling centre to dispose of the battery appropriately. Continuing to use an electric bike lithium battery that has been used for more than 5 years carries an increasing risk with each year of age beyond 5 years use of deterioration in critical safety related functions. Be smart, recycle your old lithium batteries, and be safe. Please contact us through [gocycle.com/support](https://gocycle.com/support) for a “Responsible Battery Recycling” coupon that can be used towards the purchase of a new replacement lithium battery. You will need to show valid proof of regular maintenance and annual servicing to qualify for a coupon.
- Before first use, ensure that your battery is fully charged.
- Heat accelerates the degradation of batteries. Avoid operating or storing the battery in high temperatures when possible.
- Riding in cold weather will reduce the range of the battery by up to 50%.
- Do not allow a nearly depleted battery to be unused for more than one month. The battery will slowly discharge until it becomes fully discharged, and this will permanently damage the battery.
- Lithium-ion batteries are classified as Miscellaneous Class 9 Dangerous Goods. Consult your local authority for further advice on storage, handling and shipping.
- Like any lithium-ion battery, the Gocycle lithium-ion battery is classified as Miscellaneous Class 9 Dangerous Goods, and as such, must be packaged, shipped and handled in accordance with the strict guidelines laid out by the relevant international regulatory bodies for air, sea and road transport.
- Never attempt to transport your lithium-ion battery by air without first seeking the prior approval of your airline. Do not discard any of the battery packaging materials.
- Do not dispose of batteries with general household waste.
- Best practice for long term storage is to deplete the battery to 30-50% of maximum charge and store in the Gocycle in a dry environment. Do not leave the charger plugged into the battery for more than 24 hours.

## 5 UNDERSTANDING YOUR GOCYCLE

It's important to your safety, performance and enjoyment to understand how things work on your Gocycle. We urge you to ask your Gocycle dealer how to do the things described in this section before you attempt them yourself, and that you have your Gocycle dealer check your work before you ride the bike. If you have even the slightest doubt as to whether you understand something in this section of the Manual, talk to your Gocycle dealer or Gocycle. *See also the Appendix.*

### 5.1 Quick Release Pitstopwheels



**WARNING: If your Gocycle has quick release Pitstopwheels, ensure that all quick release cam levers are in the closed position and the PistopLock is rotated in the direction shown to the fully closed position.**

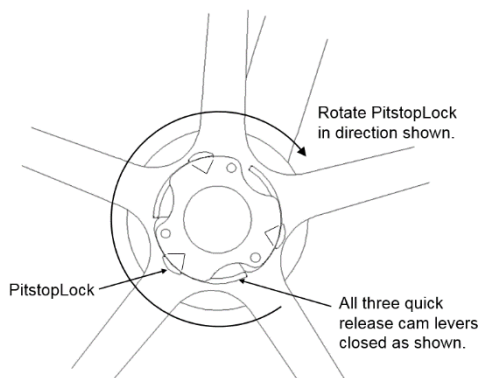

## 5.2 Folding Frame and Handlebar Latches

**⚠ WARNING:** If your Gocycle has folding frame and handlebar latches such as GX/GXi models, before each ride, you must check that the frame and handlebar latches are locked. To do this, pull hard on the latch in the direction shown to check that the latch is locked. The latch should not open. If the latch opens, the latch lock is not engaged and it is not safe to ride the Gocycle. With the latches closed, using one finger, press and release the red latch lock multiple times. If the black latch opens, the latch is not functioning properly and you should not ride your Gocycle. Consult your Gocycle dealer or Gocycle for assistance. Never ride your Gocycle without first checking that the frame and handlebar latches are locked and the latch lock is fully engaged.

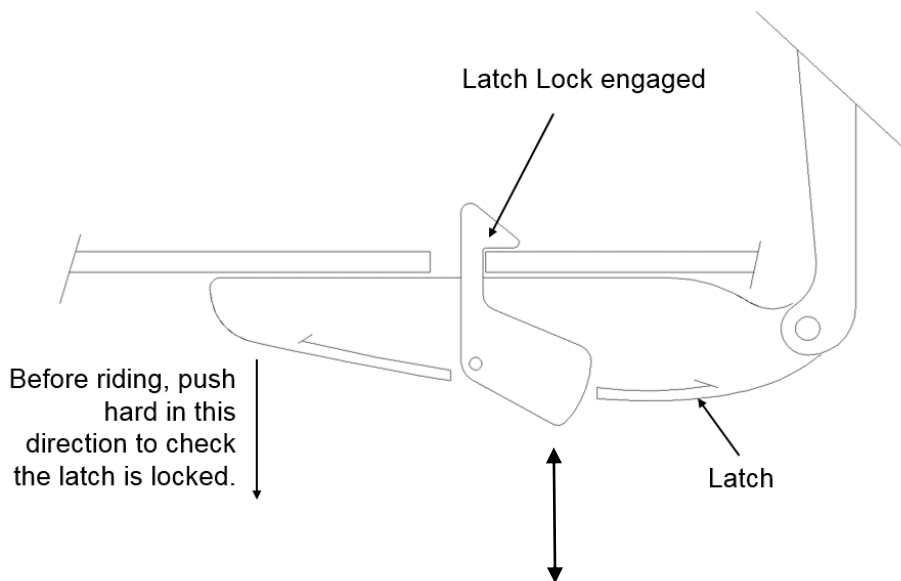



## 5.3 Brake Controls and Features

It's very important to your safety that you learn and remember which brake lever controls which brake on your bike. Traditionally, in the U.S. the right brake lever controls the rear brake and the left brake lever controls the front brake; but, to check how your bike's brakes are set up, squeeze one brake lever and move the Gocycle forwards or backwards and see which wheel is stopped, front or rear. Now do the same with the other brake lever.

Make sure that your hands can reach and squeeze the brake levers comfortably. If your hands are too small to operate the levers comfortably, consult your Gocycle dealer before riding the bike. The lever reach may be adjustable; or you may need a different brake lever design.

### 5.3.1 How Brakes Work

The braking action of a Gocycle is a function of the friction between the braking surfaces. To make sure that you have maximum friction available, keep your disk rotor and calliper clean and free of dirt, lubricants, waxes or polishes.

Brakes are designed to control your speed, not just to stop the bike. Maximum braking force for each wheel occurs at the point just before the wheel "locks up" (stops rotating) and starts to skid. Once the tire skids, you actually lose most of your stopping force and all directional control. You need to practice slowing and stopping smoothly without locking up a wheel. The technique is called progressive brake modulation. Instead of jerking the brake lever to the position where you think you'll generate appropriate braking force, squeeze the lever, progressively increasing the braking force. If you feel the wheel begin to lock up, release pressure just a little to keep the wheel rotating just short of lockup. It's important to develop a feel for the amount of brake lever pressure required for each wheel at different speeds and on different surfaces. To better understand this, experiment a little by walking your bike and applying different amounts of pressure to each brake lever, until the wheel locks.

When you apply one or both brakes, the bike begins to slow, but your body wants to continue at the speed at which it was going. This causes a transfer of weight to the front wheel (or, under heavy braking, around the front wheel hub, which could send you flying over the handlebars).

A wheel with more weight on it will accept greater brake pressure before lockup; a wheel with less weight will lock up with less brake pressure.

So, as you apply brakes and your weight is transferred forward, you need to shift your body toward the rear of the bike, to transfer weight back on to the rear wheel; and at the same time, you need to both decrease rear braking and increase front braking force. This is even more important on descents, because descents shift weight forward.

Two keys to effective speed control and safe stopping are controlling wheel lockup and weight transfer. Practice braking and weight transfer techniques where there is no traffic or other hazards and distractions.

Everything changes when you ride on loose surfaces or in wet weather. It will take longer to stop on loose surfaces or in wet weather. Tire adhesion is reduced, so the wheels have less cornering and braking traction and can lock up with less brake force. Moisture or dirt on the brake pads reduces their ability to grip. The way to maintain control on loose or wet surfaces is to go more slowly.



**CAUTION: Disc brakes can get extremely hot with extended use. Be careful not to touch a disc brake until it has had plenty of time to cool.**

- See the brake manufacturer's instructions for operation and care of your brakes, and for when brake pads must be replaced. If you do not have the manufacturer's instructions, see your Gocycle dealer or contact the brake manufacturer.
- If replacing worn or damaged parts, use only manufacturer-approved genuine replacement parts.



## 5.4 Shifting gears

Your multi-speed Gocycle has a 3 speed internal gear hub drivetrain.

### 5.4.1 Shifting Gears

Your Gocycle comes fitted with rotary shifting controls.

The vocabulary of shifting can be pretty confusing. A downshift is a shift to a “lower” or “slower” gear, one that is easier to pedal. An upshift is a shift to a “higher” or “faster”, harder to pedal gear.

### 5.4.2 Shifting Internal Gear Hub Gears

Shifting with an internal gear hub drivetrain is simply a matter of moving the shifter to the indicated position for the desired gear ratio. After you have moved the shifter to the gear position of your choice, ease the pressure on the pedals for an instant to allow the hub to complete the shift.

### 5.4.3 Which Gear Should I be in?

The numerically lowest gear (1) is for the steepest hills. The numerically largest gear is for the greatest speed.

Shifting from an easier, “slower” gear (like 1) to a harder, “faster” gear (like 2 or 3) is called an upshift. Shifting from a harder, “faster” gear to an easier, “slower” gear is called a downshift. It is not necessary to shift gears in sequence. Instead, find the “starting gear” for the conditions — a gear which is hard enough for quick acceleration but easy enough to let you start from a stop without wobbling — and experiment with upshifting and downshifting to get a feel for the different gears. At first, practice shifting where there are no obstacles, hazards or other traffic, until you’ve built up your confidence. Learn to anticipate the need to shift, and shift to a lower gear *before* the hill gets too steep. If you have difficulties with shifting, the problem could be mechanical adjustment. See your Gocycle dealer for help.

### 5.4.4 What if it won't Shift Gears?

If moving the shift control one click repeatedly fails to result in a smooth shift to the next gear chances are that the mechanism is out of adjustment. Contact your Gocycle dealer or Gocycle for further assistance.

## 5.5 Pedals

1. During turning, keeping the inside pedal up and the outside pedal down when making sharp turns will avoid the pedals hitting the ground when the Gocycle leans over. This technique will prevent the inside pedal from striking the ground in a turn.
2. Pedals have sharp and potentially dangerous surfaces. These surfaces are designed to add safety by increasing grip between the rider's shoe and the pedal. Take extra care to avoid serious injury from the pedals' sharp surfaces. Based on your riding style or skill level, you may prefer to fit different pedals. Your Gocycle dealer can show you a number of options and make suitable recommendations.

## 5.6 Tires and Tubes

### 5.6.1 Tires

Tire design, compatibility, and quality control varies widely between different tire manufacturers. Only use Gocycle approved tires on your Gocycle. Replacement tires can be ordered from [www.gocycle.com](http://www.gocycle.com) or your local Gocycle dealer. Fitting over size tires or cargo bike tires could invalidate the warranty and may be dangerous and could cause a catastrophic failure of the tire or the tire and wheel. Inflating the tires to high then specified pressures is dangerous. Take particular care during wet or icy conditions when using the Gocycle Performance tire. The Gocycle All Weather tire provides more traction and control in wet or icy conditions than the Gocycle Performance tire.





The maximum inflation pressure is marked on the sidewall of the tire. The part of this information which is most important to you is Tire Pressure. The recommended tire pressure range for Gocycle tires can be found as below:

We recommend that you operate Gocycle with tyre pressures of 30-35 psi on the front and 35-40 psi on the rear. This will give the best balance of low rolling resistance and comfort. Running a relatively softer front acts as a "cushioning effect". Running the front tyre at lower pressures than 35 psi can improve comfort and shock absorption at the expense of tyre performance, handling, and tyre life. Please ensure that you are confident and comfortable with the handling and riding characteristics of the Gocycle if you choose to run lower tyre pressures.

Never inflate the tyres to more than the stated maximum pressure on the sidewall of the tyre. Never exceed 40 psi for any tyre fitted on the Gocycle.

**CAUTION! Operating the Gocycle with a front tyre pressure greater than 35psi and/or using the motor assistance on rough terrain, against these recommendations, can reduce the service life of the motor drive system**



**WARNING: Never inflate a tire beyond the maximum pressure marked on the tire's sidewall or the wheel rim. If the maximum pressure rating for the wheel rim is lower than the maximum pressure shown on the tire, always use the lower rating. Exceeding the recommended maximum pressure may blow the tire off the rim or damage the wheel rim, which could cause damage to the bike and injury to the rider and bystanders.**

The best and safest way to inflate a tire to the correct pressure is with a bicycle pump that has a built-in pressure gauge.



**WARNING: There is a safety risk in using gas station air hoses or other air compressors. They are not made for bicycle tires. They move a large volume of air very rapidly, and will raise the pressure in your tire very rapidly, which could cause the tube to explode.**

Tire pressure is given either as maximum pressure or as a pressure range. How a tire performs under different terrain or weather conditions depends largely on tire pressure. Inflating the tire to near its maximum recommended pressure gives the lowest rolling resistance; but also produces the harshest ride. High pressures work best on smooth, dry pavement.

Very low pressures, at the bottom of the recommended pressure range, give the best performance on smooth, slick terrain such as hard-packed clay, and on deep, loose surfaces such as deep, dry sand.

Tire pressure that is too low for your weight and the riding conditions can cause a puncture of the tube by allowing the tire to deform sufficiently to pinch the inner tube between the rim and the riding surface. This may also result in rim damage.



**CAUTION: Pencil type automotive tire gauges can be inaccurate and should not be relied upon for consistent, accurate pressure readings. Instead, use a high quality dial or digital gauge.**

If you need help with tires, ask your Gocycle dealer to recommend the best tire pressure for the kind of riding you will most often do, and have the Gocycle dealer inflate your tires to that pressure. Then, check inflation as described in Section 1.C so you'll know how correctly inflated tires should look and feel when you don't have access to a gauge. Some tires may need to be brought up to pressure every week or two, so it is important to check your tire pressures before every ride.

Gocycle tires have unidirectional treads: their tread pattern is designed to work better in one direction than in the other.

### 5.6.2 Tire Tube Valves

There are primarily two kinds of bicycle tire valves: The Schrader Valve and the Presta Valve. The bicycle pump you use must have the fitting appropriate to the valve stems on your Gocycle.

The Schrader valve (fig. 18a) is like the valve on a car tire. To inflate a Schrader valve tire, remove the valve cap and clamp the pump fitting onto the end of the valve stem. To let air out of a Schrader valve, depress the pin in the end of the valve stem with the end of a key or other appropriate object.



Gocycle rims are designed to use Schrader type valve tire tubes. Ensure that the tube you use is compatible with the size of the Gocycle tire. Consult your Gocycle dealer or Gocycle for assistance.

The Presta valve (fig. 18b) has a narrower diameter and is only found on bicycle tires. Gocycle rims are not designed to be compatible with Presta valve type tire tubes. Do not use Presta valve type tire tubes on your Gocycle.

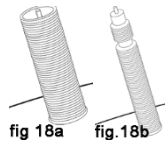

**WARNING:** We highly recommend that you carry a spare inner tube when you ride your Gocycle. Patching a tube is an emergency repair. If you do not apply the patch correctly or apply several patches, the tube can fail, resulting in possible tube failure, which could cause you to lose control and fall. Replace a patched tube as soon as possible.

## 6 SERVICE



**WARNING:** Gocycles and Gocycle components are technically complex and new developments are being added continually and the pace of electric bicycle innovation is increasing. It is impossible for this manual to provide all the information required to properly repair and/or maintain your Gocycle. In order to help minimize the chances of an accident and possible injury, it is critical that you have any repair or maintenance that is not specifically described in this manual performed by your Gocycle dealer or Gocycle. Equally important is that your individual maintenance requirements will be determined by everything from your riding style to geographic location. Consult your Gocycle dealer for help in determining your maintenance requirements.



**WARNING:** You must visit [www.gocycle.com/safety](http://www.gocycle.com/safety) at least one every 3 months to check and read if there are any new Technical Bulletins relating to your Gocycle or a new version of the Gocycle owner's manual.



**WARNING:** Many Gocycle service and repair tasks require special knowledge and tools. Do not begin any adjustments or service on your Gocycle until you have learned from your Gocycle dealer or Gocycle how to properly complete them. Improper adjustment or service may result in damage to the Gocycle or in an accident which can cause serious injury or death.

If you want to learn to do major service and repair work on your bike:

1. Ask your Gocycle dealer for copies of the manufacturer's installation and service instructions for the components on your bike, or contact Gocycle.
2. Use an appropriately recommended book on bicycle repair to help build your broad knowledge on bicycle repair.
3. Ask your local bicycle dealer about the availability of bicycle repair courses in your area.

We recommend that you ask your Gocycle dealer to check the quality of your work the first time you work on something and before you ride the bike, just to make sure that you did everything correctly. Since that will require the time of a mechanic, there may be a modest charge for this service.

We also recommend that you ask your Gocycle dealer for guidance on what spare parts, such as tires, inner tubes, light bulbs, batteries, Patch Kit, lubricants etc. it would be appropriate for you to have once you have learned how to replace such parts when they require replacement.



### 6.1.1 Service Intervals

Recommended Service Interval	Performed By	Distance Ridden	Time
Pre-Ride Checklist	Owner	Before each ride	Before each ride
Visual Inspection / Service if required	Owner or Authorized Gocycle Reseller (recommended)	After first 100 miles/160 kms	2 months after first ride
Visual Inspection	Owner	Every 500 miles/800 kms	Every 3 months
Visit <a href="http://www.gocycle.com/safety">www.gocycle.com/safety</a>	Owner		Every 3 months
Check and Update to latest Firmware Version	Owner		Every 3 months
Visual Inspection / Service recommended	Owner or Authorised Gocycle Reseller (recommended)	Every 2000 miles/3200 kms	Annually

Some service and maintenance can and should be performed by the owner, and require no special tools or knowledge beyond what is presented in the manual relating to service.

The following are examples of the type of service you should perform yourself. All other service, maintenance and repair should be performed in a properly equipped facility by a qualified bicycle mechanic using the correct tools and procedures specified by Gocycle.

1. **Break-in Period:** Your bike will last longer and work better if you break it in before riding it hard. Control cables and fasteners may stretch, relax or “seat” when a new bike is first used and may require readjustment by your Gocycle dealer. Your Mechanical Safety Check (Section 2) will help you identify some things that need readjustment. But even if everything seems fine to you, it's best to take your Gocycle back to the Gocycle dealer or to Gocycle for a check-up. Gocycle dealers typically suggest you bring the bike in for a 30-day check-up. Another way to judge when it's time for the first check-up is to bring the bike in after 10 to 15 hours of riding. But if you think something is wrong with the bike, take it to your Gocycle dealer before riding it again.
2. **Before every ride:** Pre-ride Checks
3. **After every long or hard ride;** if the Gocycle has been exposed to water or grit; or at least every 100 miles: Clean the Gocycle.
4. **After every long or hard ride or after every 10 to 20 hours of riding:**
  - Squeeze the front brake and rock the bike forward and back. Everything feel solid? If you feel a clunk with each forward or backward movement of the bike, you probably have a loose headset. Have your Gocycle dealer check it or refer to the Gocycle service manual.
  - Lift the front wheel off the ground and swing it from side to side. Feel smooth? If you feel any binding or roughness in the steering, you may have a tight headset. Have your Gocycle dealer check it or refer to the Gocycle service manual.
  - Grab one pedal and rock it toward and away from the centreline of the bike; then do the same with the other pedal. Anything feel loose? If so, have your Gocycle dealer check it or refer to the Gocycle service manual.
  - Carefully check the control cables and cable housings. Any rust? Kinks? Fraying? If so, have your Gocycle dealer check them or contact Gocycle for further assistance.



- Check the tires for excess wear, cuts or bruises. Have your Gocycle dealer replace them if necessary.
  - Check the wheel rims for excess wear, dings, dents and scratches. Consult your Gocycle dealer if you see any rim damage.
  - Check to make sure that all parts and accessories are still secure, and tighten any that are not.
  - Check the frame and wheels, particularly in the area around all tube joints; the handlebars; the stem; the spokes and rims; and the seat post for any deep scratches, cracks or discoloration. These are signs of stress-caused fatigue and indicate that a part is at the end of its useful life and needs to be replaced. See also the Appendix.
5. Disc brakes require a different set of inspection steps. Check for these issues before every ride:
- Pads rubbing on rotors.
  - Worn out pads (which can lead to over-extended pistons).
  - Pistons that are stuck and/or won't retract fully.
  - Disc rotors that are bent and need straightening by your Gocycle dealer.
  - Hydraulic brakes that feel "sponge-y" and/or levers that can be depressed all the way to the grips w/o generating adequate stopping power (due to trapped air and/or leaks).



**WARNING: Like any mechanical device, a Gocycle and its components are subject to wear and stress. Different materials and mechanisms wear or fatigue from stress at different rates and have different life cycles. If a component's life cycle is exceeded, the component can suddenly and catastrophically fail, causing serious injury or death to the rider**

Scratches, cracks, fraying and discoloration are signs of stress-caused fatigue and indicate that a part is at the end of its useful life and needs to be replaced. While the materials and workmanship of your Gocycle or of individual components may be covered by a warranty for a specified period of time by the manufacturer, this is no guarantee that the product will last the term of the warranty. Product life is often related to the kind of riding you do and to the treatment to which you submit the Gocycle. The Gocycle's warranty is not meant to suggest that the Gocycle cannot be broken or will last forever. It only means that the Gocycle is covered subject to the terms of the warranty. Please be sure to read the Appendix - Intended Use of your Gocycle and - The lifespan of your bike and its components.

6. As required: If either brake lever fails the Mechanical Safety Check (Section 1.C), don't ride the bike. Have your Gocycle dealer check the brakes or contact Gocycle for assistance.
7. Every 50 (on-road) hours of riding: Take your bike to your Gocycle dealer for a complete check-up.

### 6.1.2 If your Gocycle sustains an impact

First, check yourself for injuries, and take care of them as best you can. Seek medical help if necessary. Next, check your Gocycle for damage.

After any crash, take your Gocycle to your Gocycle dealer for a thorough check. Carbon composite components such as those found on the Gocycle carbon models, including frames, wheels, handlebars, stems, cranksets, brakes, etc. which have sustained an impact *must not* be ridden until they have been disassembled and thoroughly inspected by a qualified mechanic.

See also the Appendix, *Lifespan of your bike and its components*.



**WARNING: A crash or other impact can put extraordinary stress on Gocycle components, causing them to fatigue prematurely. Components suffering from stress fatigue can fail suddenly and catastrophically, causing loss of control, serious injury or death.**



## 7 APPENDIX

### 7.1 Intended Use

Gocycle is an electric bicycle developed and designed for on paced road commuting usage and/or simple riding in fair weather and at speeds relevant to safe and appropriate travel in an urban or suburban environment. Where applicable, the product meets the minimum requirements outlined in EN 15194:2017. Abusive riding styles or inappropriate use will invalidate any warranty protection offered in this agreement.



**WARNING! Understand your Gocycle and its intended use. Using your Gocycle in the wrong manner or for the wrong purpose can be dangerous and may impact the service life of the product.**

The Gocycle is a power-assisted bicycle intended for sensible use by physically competent riders. If you have any concerns or doubts about your use or enjoyment of such a product due to a medical condition, an illness or if you are recovering from treatment for a condition or illness, you should consult your doctor regarding the suitability of the product for you. If you are a vulnerable person, we strongly recommend that you seek assistance from your local dealer to configure, setup, and maintain your Gocycle as well as providing you advice on whether the product is suitable for you.

WARNING! Regulations for electric bicycle vary throughout the world and are constantly being updated. There may be usage limitation in place in your local region restricting access on certain bike paths, roads, parks or other common use areas. We strongly recommend that you consult your local electric bicycle regulatory body and understand the legislation prior to operating this product. Whilst most electric bicycles operated in accordance with local legislation are treated in a similar manner to a bicycle, your insurance provider may have a different policy with regards to bicycles and electric bicycles. We also strongly recommend that you consult your insurance provider and notify them about your intended usage of this product prior to operation.

### 7.2 Modifications and Refinishing

WARNING! Do not modify or refinish or fit aftermarket components to your Gocycle or Gocycle components in any way. Such modifications or refinishing will void any applicable warranty and is not safe and may cause the Gocycle to fail unexpectedly causing you to lose control resulting in injury or even death. Do not modify your Gocycle with firmware not compliant with your local regional laws and regulations.

Modifications can cause damage and can increase the risk of failure and accidents which may result in serious injury or death and can render the product non-compliant, which place you and others at risk. Refinishing can hide structural damage, such as fatigue cracks or structural problems which may also result in an accident.



**WARNING: Failure to confirm compatibility, properly install, operate and maintain any component or accessory can result in serious injury or death.**

#### 7.2.1 Changing Components or Adding Accessories

There are many components and accessories available to enhance the comfort, performance or appearance. However, if you change components or add accessories, you do so at your own risk. Gocycle may not have tested that component or accessory for compatibility, reliability or safety on your Gocycle. Before installing any component or accessory, including but not limited to a different size tire, a lighting system, a luggage rack, a child seat, a trailer, etc., make sure that it is compatible with your Gocycle by checking with Gocycle. Be sure to read, understand and follow the instructions that accompany the products you purchase for your Gocycle. *See also the Appendix.*

#### 7.2.2 Caro bike tires

**Under no circumstances should you ever use “Cargo bike” tires to the Gocycle**



Cargo bicycle tires are designed differently to normal bicycle tires and will transmit significantly higher stress loads into the bicycle frame and components compared to Gocycle tires or normal two wheel bicycle tires. Cargo bikes include 3 and 4 wheel variants and therefore the makers of "Cargo" tires account for side loadings not found on normal 2 wheel bicycles. This means that the tires are significantly stiffer and less compliant than normal bike tires and are incompatible with the Gocycle in all circumstances. This will result in a significant reduction in the life of the frame and in some cases may cause premature failure.

**All warranties will be voided if Cargo bicycle tires are fitted to the Gocycle at any time during its lifetime.**



**WARNING: Changing the components on your bike with other than genuine replacement parts may compromise the safety of your Gocycle and may void the warranty. Check with your Gocycle dealer or Gocycle before changing the components on your bike.**

### *7.3 Maximum Weight Design Limit*

WARNING! This product has been designed with a maximum recommended weight limit of 100kg (220lbs) for the rider, clothing and all luggage, and is intended for use on paved roads. For rider and luggage weight 100-115kg (220-250lbs): riding style, road condition, tire pressures and luggage position may reduce product service life. Luggage weight should not exceed 10% of total rider and luggage weight. Never exceed rider and luggage weight of 115kg (250lbs) at any time. Exceeding this limit will void all warranties and may result in the product being unsafe for operation.



## 7.4 The lifespan of your Gocycle and its components



**WARNING! Bicycles have a limited life span for safe operation and are not indestructible.**

As with all mechanical components, bicycle components are subject to wear and high stresses. Different materials and components may react to wear, stress or fatigue in different ways. Exceeding the useful life of your Gocycle may be hazardous.

The expected life span of a Gocycle or Gocycle component will vary with the material and construction of the frame and components, the maintenance that is received over its life and the type and amount of riding. Any unusual or abusive riding style, such as off-road cycling, competitive riding, stunt cycling, jumping or riding at excessive speed and braking hard, can accelerate wear and fatigue of components to the point where premature and sudden failure of a component may occur without warning and risk of injury is increased.



**WARNING! Regular maintenance is essential. See Section 7. Maintenance and Adjustments in this manual and check on [www.gocycle.com/safety](http://www.gocycle.com/safety) every 3 months to see if there are any relevant technical bulletins relating to your frame number. Failure to perform regular checks and maintenance could result in a reduced service life of the product or render the product unsafe to ride.**

Any form of crack, scratch or change of colouring in highly stressed areas indicates that the life of the component has been reached and you should replace it before any further use.

See the relevant Gocycle Product Manual that is available online at [www.gocycle.com/safety](http://www.gocycle.com/safety) for parts of the Gocycle that require visual inspection from time to time. An impact to your Gocycle, either major or minor, can cause stress and fatigue on the Gocycle and its components or compromise the integrity of the electronics, including the battery, electronic controller, motor drive system or wiring. In the event of an accident and if safe to do so switch the battery off. Check for visual damage before continuing to ride the Gocycle. If the Gocycle has sustained damage other than light cosmetic scratches such as dented, cracked, bent or misaligned components, do not ride your Gocycle until it has been inspected by an authorised Gocycle service centre. If you are qualified to inspect your Gocycle, consult [techsupport@gocycle.com](mailto:techsupport@gocycle.com).

### 7.4.1 Nothing Lasts Forever, Including Your Gocycle.

When the useful life of your Gocycle or its components is over, continued use is hazardous.

Every Gocycle and its component parts have a finite, limited useful life. The length of that life will vary with the construction and materials used in the frame and components; the maintenance and care the frame and components receive over their life; and the type and amount of use to which the frame and components are subjected. Use in competitive events, trick riding, ramp riding, jumping, aggressive riding, riding on severe terrain, riding in severe climates, riding with heavy loads, commercial activities and other types of non-standard use can dramatically shorten the life of the frame and components. Any one or a combination of these conditions may result in an unpredictable failure.

All aspects of use being identical, lightweight electric bicycles and their components will usually have a shorter life than heavier electric bicycle and their components. In selecting a lightweight electric bicycle or components you are making a trade-off, favouring the higher performance that comes with lighter weight over longevity. So, if you choose lightweight, high performance equipment, be sure to have it inspected frequently.

You should have your Gocycle and its components checked periodically as recommended by the Gocycle service interval by your Gocycle dealer or qualified person for indicators of stress and/or potential failure, including cracks, deformation, corrosion, paint peeling, dents, and any other indicators of potential problems, inappropriate use or abuse. These are important safety checks and very important to help prevent accidents, bodily injury to the rider and shortened product life.

### 7.4.2 Perspective

Today's high-performance electric bicycles require frequent and careful inspection and service. In this Appendix we try to explain some underlying material science basics and how they relate to your



Gocycle. We discuss some of the trade-offs made in designing your Gocycle and what you can expect from your Gocycle; and we provide important, basic guidelines on how to maintain and inspect it. We cannot teach you everything you need to know to properly inspect and service your Gocycle; and that is why we repeatedly urge you to take your Gocycle to your Gocycle dealer or seek appropriate assistance from Gocycle or a qualified bicycle mechanic for professional care and attention.



**WARNING: Frequent inspection of your Gocycle is important to your safety. Follow the Pre-Ride Checks in Section 2 of this manual before every ride.**

Periodic, more detailed inspection of your Gocycle is important. How often this more detailed inspection is needed depends upon you.

You, the rider/owner, have control and knowledge of how often you use your bike, how hard you use it and where you use it. Because your Gocycle dealer or Gocycle cannot track your use, you must take responsibility for periodically bringing your bike to your Gocycle dealer or returning it to Gocycle for inspection and service. Your Gocycle dealer will help you decide what frequency of inspection and service is appropriate for how and where you use your bike.

For your safety, understanding and communication with your Gocycle dealer or Gocycle, we urge you to read this Appendix in its entirety. The materials used to make your Gocycle determine how and how frequently to inspect.



**Ignoring this WARNING can lead to frame, fork or other component failure, which can result in serious injury or death.**

### 7.4.3 Understanding metals

Steel is the traditional material for building bicycle frames. It has good characteristics, but in high performance bicycles, steel has been largely replaced by aluminium and some titanium and magnesium. The main factor driving this change is interest in lighter electric bicycles by cycling enthusiasts.

### 7.4.4 Properties of Metals

Please understand that there is no simple statement that can be made that characterizes the use of different metals for bicycles. What is true is how the metal chosen is applied is much more important than the material alone. One must look at the way the bike is designed, tested, manufactured, supported along with the characteristics of the metal rather than seeking a simplistic answer.

Metals vary widely in their resistance to corrosion. Steel must be protected or rust will attack it. Aluminium and Titanium and magnesium quickly develop an oxide film that protects the metal from further corrosion. Both are therefore quite resistant to corrosion. Aluminium and magnesium are not perfectly corrosion resistant, and particular care must be used where it contacts other metals and galvanic corrosion can occur.

Metals are comparatively ductile. Ductile means bending, buckling and stretching before breaking. Generally speaking, of the common bicycle frame building materials steel is the most ductile, titanium less ductile, followed by Aluminium and magnesium.

Metals vary in density. Density is weight per unit of material. Steel weighs 7.8 grams/cm<sup>3</sup> (grams per cubic centimetre), titanium 4.5 grams/cm<sup>3</sup>, Aluminium 2.75 grams/cm<sup>3</sup>, magnesium 1.8 grams/cm<sup>3</sup>, carbon fibre composite at 1.45 grams/cm<sup>3</sup>.

Metals are subject to fatigue. With enough cycles of use, at high enough loads, metals will eventually develop cracks that lead to failure. It is very important that you read the basics of metal fatigue below.

Let's say you hit a curb, ditch, rock, car, another cyclist or other object. At any speed above a fast walk, your body will continue to move forward, momentum carrying you over the front of the bike. You cannot and will not stay on the bike, and what happens to the frame, fork and other components is irrelevant to what happens to your body.





What should you expect from your metal frame? It depends on many complex factors, which is why we tell you that crashworthiness cannot be a design criteria. With that important note, we can tell you that if the impact is hard enough the fork or frame may be bent or buckled. On a steel bike, the steel fork may be severely bent and the frame undamaged. Aluminium and magnesium is less ductile than steel, but you can expect the fork and frame to be bent or buckled. Hit harder and the frame components or wheels may be broken or buckled, leaving the head tube and fork separated from the frame.

When a metal bike crashes, you will usually see some evidence of this ductility in bent, buckled or folded metal.

**7.4.5 The basics of metal fatigue**

Common sense tells us that nothing that is used lasts forever. The more you use something, and the harder you use it, and the worse the conditions you use it in, the shorter its life.

Fatigue is the term used to describe accumulated damage to a part caused by repeated loading. To cause fatigue damage, the load the part receives must be great enough. A crude, often-used example is bending a paper clip back and forth (repeated loading) until it breaks. This simple definition will help you understand that fatigue has nothing to do with time or age.

So what kind of “damage” are we talking about? On a microscopic level, a crack forms in a highly stressed area. As the load is repeatedly applied, the crack grows. At some point the crack becomes visible to the naked eye. Eventually it becomes so large that the part is too weak to carry the load that it could carry without the crack. At that point there can be a complete and immediate failure of the part.

One can design a part that is so strong that fatigue life is nearly infinite. This requires a lot of material and a lot of weight. Any structure that must be light and strong will have a finite fatigue life. Aircraft, race cars, motorcycles all have parts with finite fatigue lives. If you wanted a Gocycle with an infinite fatigue life, it would weigh far more than any bicycle sold today. The wonderful, lightweight performance we want requires that we inspect the structure.

**7.4.6 What to look for**

<ul style="list-style-type: none"> <li>• ONCE A CRACKS STARTS IT CAN GROW AND GROW FAST. Think about the crack as forming a pathway to failure. This means that any crack is potentially dangerous and will only become more dangerous.</li> </ul>	<p>SIMPLE RULE 1: If you find crack, replace the part.</p>
<ul style="list-style-type: none"> <li>• CORROSION SPEEDS DAMAGE. Cracks grow more quickly when they are in a corrosive environment. Think about the corrosive solution as further weakening and extending the crack.</li> </ul>	<p>SIMPLE RULE 2: Clean your Gocycle, protect your Gocycle from salt, remove any salt as soon as you can.</p>
<ul style="list-style-type: none"> <li>• SIGNIFICANT SCRATCHES, GOUGES, DENTS OR SCORING CREATE STARTING POINTS FOR CRACKS. Think about the cut surface as a focal point for stress (in fact engineers call such areas “stress risers,” areas where the stress is increased). Perhaps you have seen glass cut? Recall how the glass was scored and then broke on the scored line.</li> </ul>	<p>SIMPLE RULE 4: Do not scratch, gouge or score any surface. If you do, pay frequent attention to this area or replace the part.</p>

**7.4.7 Fatigue is Not a Perfectly Predictable Science**

Fatigue is not a perfectly predictable science, but here are some general factors to help you and your Gocycle dealer or Gocycle determine how often your Gocycle should be inspected. The more you fit



the “shorten product life” profile, the more frequent your need to inspect. The more you fit the “lengthen product life” profile, the less frequent your need to inspect.

#### 7.4.8 Factors that shorten product life:

- Hard, harsh riding style
- “Hits”, crashes, jumps, other “shots” to the bike
- Rough or potholed roads
- High mileage
- Higher body weight
- Stronger, more fit, more aggressive rider
- Corrosive environment (wet, salt air, winter road salt, accumulated sweat)
- Presence of abrasive mud, dirt, sand, soil in riding environment

#### 7.4.9 Factors that lengthen product life:

- Smooth, fluid riding style
- No “hits”, crashes, jumps, other “shots” to the bike
- Smooth, well maintained roads
- Low mileage
- Lower body weight
- Less aggressive rider
- Non-corrosive environment (dry, salt-free air)
- Clean riding environment



**WARNING: Do not ride a Gocycle or component with any crack, bulge or dent, even a small one. Riding a cracked frame, wheel, rim, fork or component could lead to complete failure, with risk of serious injury or death.**

#### 7.4.10 Understanding composites

All riders must understand a fundamental reality of composites. Composite materials constructed of carbon fibres are strong and light, but when crashed or overloaded, carbon fibres do not bend, they break.

#### 7.4.11 What Are Composites?

The term “composites” refers to the fact that a part or parts are made up of different components or materials. You’ve heard the term “carbon fibre bike.” This really means “composite bike.”

Carbon fibre composites are typically a strong, light fibre in a matrix of plastic, moulded to form a shape. Carbon composites are light relative to metals. Steel weighs 7.8 grams/cm<sup>3</sup> (grams per cubic centimetre), titanium 4.5 grams/cm<sup>3</sup>, aluminium 2.75 grams/cm<sup>3</sup>, magnesium 1.8 grams/cm<sup>3</sup>. Contrast these numbers with carbon fibre composite at 1.45 grams/cm<sup>3</sup>.

The composites with the best strength-to-weight ratios are made of carbon fibre in a matrix of epoxy plastic. The epoxy matrix bonds the carbon fibres together, transfers load to other fibres, and provides a smooth outer surface. The carbon fibres are the “skeleton” that carries the load.

#### 7.4.12 Why Are Composites Used?

Unlike metals, which have uniform properties in all directions (engineers call this isotropic), carbon fibres can be placed in specific orientations to optimize the structure for particular loads. The choice of where to place the carbon fibres gives engineers a powerful tool to create strong, light bicycles. Engineers may also orient fibres to suit other goals such as comfort and vibration damping.



Carbon fibre composites are very corrosion resistant, much more so than most metals.

Think about carbon fibre or fibreglass boats.

Carbon fibre materials have a very high strength-to-weight ratio.

#### 7.4.13 What Are The Limits Of Composites?

Well designed “composite” or carbon fibre bicycles and components have long fatigue lives, usually better than their metal equivalents.

While fatigue life is an advantage of carbon fibre, you must still regularly inspect your carbon fibre frame, fork, or components.

Carbon fibre composites are not ductile. Once a carbon structure is overloaded, it will not bend; it will break. At and near the break, there will be rough, sharp edges and maybe delamination of carbon fibre or carbon fibre fabric layers. There will be no bending, buckling, or stretching.

#### 7.4.14 If You Hit Something Or Have A Crash, What Can You Expect From Your Carbon Fibre Bike?

Let's say you hit a curb, ditch, rock, car, other cyclist or other object. At any speed above a fast walk, your body will continue to move forward, the momentum carrying you over the front of the bike. You cannot and will not stay on the bike and what happens to the frame, fork and other components is irrelevant to what happens to your body.

What should you expect from your carbon frame? It depends on many complex factors. But we can tell you that if the impact is hard enough, the carbon fibre component may be completely broken. Note the significant difference in behaviour between carbon and metal. *See Section 2. A, Understanding metals* in this Appendix. Even if the carbon frame was twice as strong as a metal frame, once the carbon frame is overloaded it will not bend, it will break completely.



**WARNING: Be aware that high temperature in a confined environment can affect the integrity of composite materials, resulting in component failure which could cause you to lose control and fall.**

#### 7.4.15 Inspection of Composite Frame, Fork, and Components

##### 7.4.16 Cracks

Inspect for cracks, broken, or splintered areas. Any crack is serious. Do not ride any Gocycle or component that has a crack of any size.

Delamination is serious damage. Composites are made from layers of fabric. Delamination means that the layers of fabric are no longer bonded together. Do not ride any Gocycle or component that has any delamination. These are some delamination clues:

1. A cloudy or white area. This kind of area looks different from the ordinary undamaged areas. Undamaged areas will look glassy, shiny, or “deep,” as if one was looking into a clear liquid. Delaminated areas will look opaque and cloudy.
2. Bulging or deformed shape. If delamination occurs, the surface shape may change. The surface may have a bump, a bulge, soft spot, or not be smooth and fair.
3. A difference in sound when tapping the surface. If you gently tap the surface of an undamaged composite you will hear a consistent sound, usually a hard, sharp sound. If you then tap a delaminated area, you will hear a different sound, usually duller, less sharp.

##### 7.4.17 Unusual Noises

Regular creaking noises such as in time with your pedalling, the wheels turning, or your regular pulling or pushing, or bobbing of the suspension system could indicate loose or maladjusted components or a problem. A well maintained Gocycle should be generally free of creaks and squeaks that occur rhythmically with pedal, wheel, bobbing movements. Investigate and find the source of any



noise. It may not be a crack or delamination, but whatever is causing the noise must be fixed or replaced before riding. Occasional creaks or squeaks or creaks or squeaks that are related to lubrication or temperature variations or changes in humidity do occur with normal riding and as the product ages.



**WARNING: Do not ride a Gocycle or component with any delamination or crack. Riding a delaminated or cracked frame, fork or other component could lead to complete failure, with risk of serious injury or death.**

#### **7.4.18 Understanding components**

It is often necessary to remove and disassemble components in order to properly and carefully inspect them. This is a job for a professional bicycle mechanic with the special tools, skills and experience to inspect and service your Gocycle to Gocycle's approved procedures.

#### **7.4.19 Aftermarket "Super Light" components**

Think carefully about your rider profile as outlined above. The more you fit the "shorten product life" profile, the more you must question the use of super light components. The more you fit the "lengthen product life" profile, the more likely it is that lighter components may be suitable for you. Discuss your needs and your profile very honestly with your Gocycle dealer or Gocycle.

Take these choices seriously and understand that you are responsible for the changes.

A useful slogan to discuss with your Gocycle dealer if you contemplate changing components is "Strong, Light, or Cheap –pick any two."

#### **7.4.20 Original Equipment components**

Gocycle tests the fatigue life of the components that are original equipment on your bike. This means that they have met test criteria and have reasonable fatigue life. It does not mean that the original components will last forever. They won't.

### *7.5 Fastener Torque Specifications*

**Correct tightening torque of threaded fasteners is very important to your safety. Always tighten fasteners to the correct torque. In case of a conflict between the instructions in this manual and information provided by a component manufacturer, consult with your Gocycle dealer or the manufacturer's customer service representative for clarification. Bolts that are too tight can stretch and deform. Bolts that are too loose can move and fatigue. Either mistake can lead to a sudden failure of the bolt.**

**Always use a correctly calibrated torque wrench to tighten critical fasteners on your bike. Carefully follow the torque wrench manufacturer's instructions on the correct way to set and use the torque wrench for accurate results.**



### 7.5.1 FASTENER RECOMMENDED TORQUE

Description	Min Torque (Nm)	Max Torque (Nm)	Min Torque (ft lb)	Max Torque (ft lb)
Shear Pins	1.5	2.5	1.1	1.8
Lockshock to Frame Bolt	2	3	1.5	2.2
GX Strap Holder	2.5	3	1.8	2.2
Crown Cap Bolts	2.5	3	1.8	2.2
GX ShockLock Tophat	3	4	2.2	3.0
Frame Hinge Bolts	4	5	3.0	3.7
Stem Pivot Pin Nyloc	4	5	3.0	3.7
Grips	4	5	3.0	3.7
Brake Lever Bolts	4	5	3.0	3.7
Cleandrive Bolts	4	6	3.0	4.4
Pivot Block	4	6	3.0	4.4
PitstopWheel Bolts	5	6	3.7	4.4
Security Wheel Bolt	5	6	3.7	4.4
Seatpost Clamp Bolt	5	6	3.7	4.4
Caliper Screw	6	7	4.4	5.2
Stem Adjuster Hinge Bolts	7	8	5.2	5.9
Preload Tophat	7.5	8.5	5.5	6.3
Kickstand Tophat	8	10	5.9	7.4
Saddle Clamp	9	10	6.6	7.4
Fork Crown Pinch Bolt	10	12	7.4	8.9
Crank Arm Bolts	38	42	28.0	31.0

## 7.6 Warranty, Limitations, & Contact

Please view current warranty terms and conditions at the webstore you purchased your Gocycle from. [www.gocycle.com/webstore](http://www.gocycle.com/webstore).

### 7.6.1 Warranty Registration and Setup

In the event that you wish to make a warranty claim, you must provide your original proof of purchase (sales receipt or order confirmation). Keep this information in a safe place. Before we can process a warranty claim, you must have registered your Gocycle via the Setup process on the GocycleConnect App. Doing so will enable us to contact you with important product safety-related information, should the need arise.

**Please complete the Setup process on the GocycleConnect App to register your Gocycle for warranty and in order to stay informed of important safety notices.**

### 7.6.2 Normal Wear and Tear

There will be marking, paint erosion, and areas of wear and tear in and around the folding and latching joints which could occur immediately on folding and un-folding the GXi and is considered normal wear and tear. For best practice maintenance please refer section 11.13.

### 7.6.3 Gocycle Frame Number

Your Gocycle comes with a unique identifier called a frame number, positioned on the rear of the Gocycle. An example is shown below:

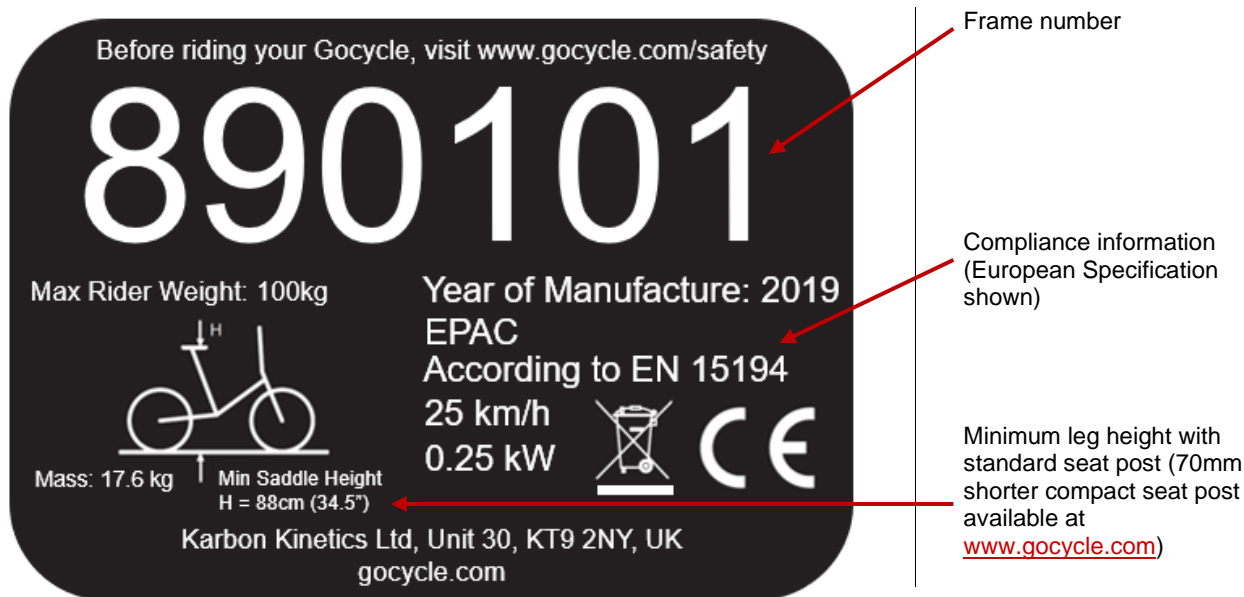

Frame number

Compliance information (European Specification shown)

Minimum leg height with standard seat post (70mm shorter compact seat post available at [www.gocycle.com](http://www.gocycle.com))

Your Gocycle frame number will be required when registering your Gocycle, making a warranty claim or making contact with Karbon Kinetics Ltd.

### 7.6.4 Limitations

The specifications, information and performance of the Gocycle and other products manufactured by or sold under license granted by Karbon Kinetics Limited and featured in this document may change without notice. The use of this information or products and the conditions under which the products are used are the sole responsibility of the buyer and/or the rider. It is the buyer's and/or rider's responsibility to determine the correct and safe selection of settings and conditions of use of the products and to periodically check the products for secure and proper operation. To the extent that the law permits, any liability which may be incurred as a result of the use of a product manufactured by or sold under license granted by Karbon Kinetics Limited is limited to the cost of repairing or replacing the failed product or component at the discretion of Karbon Kinetics Limited, either within or outside of warranty periods, and does not extend to any loss or damage which may be caused as a consequence of misuse or failure of the products. Damages to the product, other property or any persons are the responsibility of the buyer and/or rider. By using this product manufactured by or sold under license granted by Karbon Kinetics Limited, you are stating that you have read this disclaimer and agree to hold Karbon Kinetics Limited, its owner/s and any of its employees or directors free from all liabilities, that you agree you are using and operating the product at your own risk, and that no warranties or guarantees are made by Karbon Kinetics Limited, expressed or implied, on performance or operation.

### 7.6.5 Copyright Notice

© Copyright Karbon Kinetics Limited. All rights reserved.

This material provided by Karbon Kinetics Limited is the property of Karbon Kinetics Limited and is protected by copyright, trademark and other intellectual property laws. You may view this material and print this material only for personal use, provided that you maintain all copyright, trademark and other proprietary rights or notices. You may not otherwise use, reproduce, store, post, broadcast, transmit, modify, sell or make available to others or the public, content from this material without the prior written approval of Karbon Kinetics Limited.

### 7.6.6 Trademarks

Gocycle®, PitstopWheel®, Cleandrive® NoCompromises® are registered trademarks of Karbon Kinetics Limited.

Pitstoplock™, GocycleConnect™, Gocycle-to-Work™, MyGocycle™, Vgonomic™ Adjustment, Lockshock™, Shocklock™ and Performance Commuting™ are trademarks of Karbon Kinetics Limited.



All trademarks and the Gocycle logo may not be used without the prior written approval of Karbon Kinetics Limited, a United Kingdom Registered Company Number 4357956.

### 7.6.7 Standards and Conformity



This manual contains references from BPSA Adult Manual: 11th Edition, 2015

This manual meets EN ISO-4210, 16 CFR 1512 and EN 16054 Standards

Gocycle is an electric power assisted cycle developed in accordance with:

2006/42/EC	The Machinery Directive
2004/108/EC	The Electromagnetic Compatibility Directive
EN 15194:2017	Cycles - Electrically power assisted cycles - EPAC Bicycles
US Type 1 & Type 2	Electric Bicycle

### 7.6.8 Contact Information

Gocycle is a product of Karbon Kinetics Limited

Karbon Kinetics Limited  
Unit 30, Barwell Business Park  
Chessington, Surrey KT9 2NY  
United Kingdom  
Registered number 4357956

Gocycle USA LLC  
107 N Phillippi St  
Boise, Idaho 83706  
USA  
[www.gocycle.com](http://www.gocycle.com)

# Gocycle<sup>®</sup> G4

## Product Manual

for Gocycle<sup>®</sup> G4

*Version August 2024*







# Gocycle G4 Product Manual

## IMPORTANT:

This manual contains important safety, performance and service information. Read it before you take the first ride on your new Gocycle, and keep it for reference.

Additional safety, performance and service information for specific components such as suspension or pedals on your Gocycle, or for accessories such as helmets or lights that you purchase, or other accessories or modes of operation may also be available. Make sure that your Gocycle dealer has given you all the manufacturers' literature that was included with your Gocycle or accessories. In case of a conflict between the instructions in this manual and information provided by Gocycle or the component manufacturer, always follow Gocycle over the component manufacturer's instructions.

**WARNING:** Before reading this manual, you must visit [www.gocycle.com/safety](http://www.gocycle.com/safety) to check if there are any newer versions of this manual or if there are any Technical Bulletins relevant to your Gocycle model.

There may be new updates to this manual with important safety related information. Please ensure that you visit [www.gocycle.com/safety](http://www.gocycle.com/safety) to download the latest owner's manual for your product as well as reading and understanding all Technical Bulletins relating to your Gocycle and frame number. You should always use the GocycleConnect App to configure your Gocycle before your first ride or ask your Gocycle dealer to configure your Gocycle for you and convey all of the important safety information contained in the App.

If you have any questions or do not understand something, take responsibility for your safety and consult with your Gocycle dealer or Gocycle.

**NOTE:** This manual is not intended as a comprehensive use, service, repair or maintenance manual or a manual on how to fit accessories. Please see your Gocycle dealer for all service, repairs or maintenance. Your Gocycle dealer may also be able to refer you to classes, clinics or books on Gocycle use, service, repair or maintenance. If you have purchased your Gocycle directly from Gocycle, please contact us through [gocycle.com/support](http://gocycle.com/support) for assistance.

The responsibility for providing support to you and your Gocycle lies with the party that sold you the Gocycle. This is only ever an approved Gocycle dealer or Gocycle. Approved Gocycle dealers can be found on the Gocycle dealer locator on [www.gocycle.com](http://www.gocycle.com). If you require assistance for service, maintenance, or warranty repair, your first contact should be with the party that sold you the Gocycle. Gocycle can provide assistance to all Gocycle owners. However, Gocycle may require you to seek service only from the party that sold you the Gocycle.



# 1 CONTENTS

<b>1</b>	<b>Contents.....</b>	<b>3</b>
<b>2</b>	<b>Unboxing Your Gocycle .....</b>	<b>5</b>
2.1	Small Parts Bag .....	5
2.2	Unboxing.....	6
2.3	Unfolding.....	8
2.4	Adjustments .....	15
2.5	Front and Rear Reflectors .....	17
<b>3</b>	<b>Charging Your Gocycle.....</b>	<b>20</b>
3.1	Getting to Know Your Gocycle Lithium-ion Battery.....	20
3.2	Checking Your Battery Charge Level.....	21
3.3	Charging the Gocycle Battery .....	22
<b>4</b>	<b>Operation.....</b>	<b>35</b>
4.1	Battery on/off button .....	35
4.2	Familiarising Yourself with Gocycle Dashboard Display.....	36
4.3	Pre-Registration: Factory State and Delivery State Explained .....	37
4.4	Brakes .....	38
4.5	Shifting.....	38
4.6	Mini Dash .....	39
4.7	Boost Button .....	39
4.8	Riding Modes.....	40
4.9	Maximising Your Gocycle’s Motor Performance and Reliability .....	43
4.10	Motor .....	45
4.11	Folding .....	46
4.12	USB-C Port.....	53
<b>5</b>	<b>Maintenance and Adjustments .....</b>	<b>54</b>
5.1	Maintenance and Service .....	54
5.2	Service interval.....	54
5.3	Visual Inspection Guide – (Every 3 Months/500 Miles) .....	55
5.4	Cleaning and Preventing Corrosion.....	59
5.5	Lubrication.....	59
5.6	Adjusting the Brakes.....	61
5.7	Tires.....	70



5.8	Adjusting the Headset.....	71
5.9	Adjusting the Stem Latch .....	74
5.10	Adjusting the Frame Latch .....	78
5.11	Maintenance and Cleaning of the Folding Hinges.....	83
5.12	Adjusting the bearings on the Rear Hub .....	83
<b>6</b>	<b>Troubleshooting.....</b>	<b>86</b>
6.1	Service and Inspection Reminder .....	86
6.2	Diagnosis Modes .....	87
6.3	Log Upload .....	87



## 2 UNBOXING YOUR GOCYCLE

### 2.1 Small Parts Bag

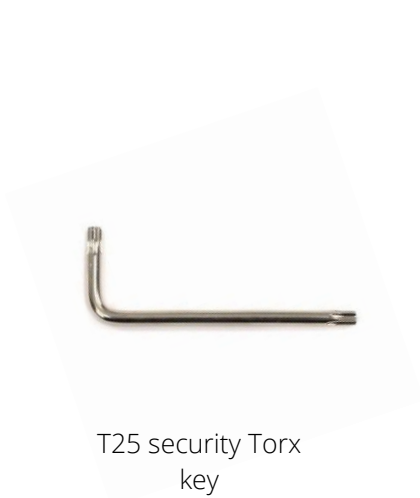

T25 security Torx key



2x Smart Phone Mount



Front Reflector and bracket



2x Security Screw

*Can replace 1 PitstopWheel screw on each wheel to prevent easy wheel removal*



Gocycle 4A Charger and Power Lead for your region



## 2.2 Unboxing



Open the G4 box.



Remove the seat collar tube.



Carefully lift the Gocycle out of the box.

 **CAUTION:** Take care when lifting the Gocycle out of the box.



Place Gocycle on the ground as shown with the Kickstand down.



We strongly recommend that you keep the Gocycle box. In the event that you need to ship your Gocycle for personal reasons or service, you must ship it in the original Gocycle box which has been specifically designed to protect the Gocycle during shipping. Failure to ship the Gocycle in the Gocycle box may result in damage to the Gocycle which will not be covered under your warranty.



## 2.3 Unfolding



Folded Gocycle.



Remove the PitstopWheel Storage Strap.

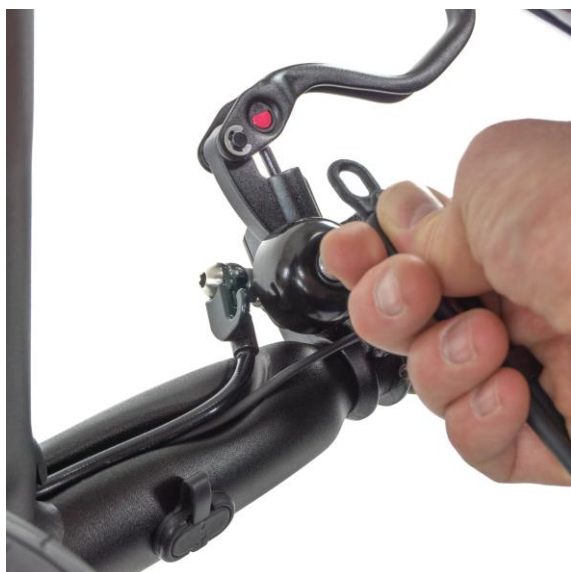

Unhook the fold strap next to the bell.



Stow the fold strap on the Lockshock pin as shown.



Unfold the handlebars.

 **CAUTION:** Keep fingers out of the folding mechanism



Close the handlebar latch as shown. The latch should begin feel tight between 25 and 35mm from the fully closed position. See [section 5](#) for maintenance and adjustment.





Check the latch is fully closed.

**⚠ WARNING:** Ensure that the red latch lock is visible and engaged with the stem as shown. If the red latch lock is not visible as shown or is not engaged with the stem, do not ride the Gocycle. Contact your local Gocycle dealer or contact us through [gocycle.com/support](https://gocycle.com/support) for assistance. Failure to check the latch is locked may result in serious injury or death.



Push hard on the latch in the direction shown to confirm that the latch is locked. Check latches are locked. Latch should not open when pushed hard in direction shown.

**⚠ WARNING:** Failure to check latch is locked may result in serious injury or death.



With the black latch closed and using only one finger, press and release the red latch lock multiple times.

- The black latch should not open and the red latch lock should remain engaged and “hooked/locked” into the frame or handlebar when released.
- The red latch lock should move freely with minimum force and it should spring back fast and sharply to the fully locked position.
- The red latch lock should not stick or squeak or freeze and it should not have a slow, partially closed or delayed action.

**⚠ WARNING:** A Gocycle with fold latches that does not pass this important safety check poses a risk of injury and must not be ridden.

Rotate the pedals so that the right-hand pedal is in the green highlighted section

**⚠ CAUTION:** Failure to correctly position the pedals may result in damage to the paint.



Unfold the frame.

 **CAUTION:** Keep fingers out of folding mechanism



Close the frame latch as shown. The latch should begin feel tight between 45mm and 55mm from the fully closed position. See [Adjusting the Frame Latch](#).



Check the latch is closed and flush with the frame.

 **WARNING:** Ensure that the red latch lock is visible and engaged with the frame as shown. If the red latch lock is not visible as shown or is not engaged with the frame, do not ride the Gocycle. Contact your local Gocycle dealer or contact us through [gocycle.com/support](http://gocycle.com/support) for support. Failure to check the latch is locked may result in serious injury or death.



Push hard on the latch in the direction shown to confirm that the latch is locked. Check latches are locked. Latch should not open when pushed hard in direction shown.

**! WARNING:** Failure to check latch is locked may result in serious injury or death.



With the black latch closed and using only one finger, press and release the red latch lock multiple times.

- The black latch should not open and the red latch lock should remain engaged and “hooked/locked” into the frame or handlebar when released.
- The red latch lock should move freely with minimum force and it should spring back fast and sharply to the fully locked position.
- The red latch lock should not stick or squeak or freeze and it should not have a slow, partially closed or delayed action.



**! WARNING:** A Gocycle with fold latches that does not pass this important safety check poses a risk of injury and must not be ridden.



Insert the seat post into the frame as shown. The 'MIN INSERT' line must not be visible.

 **WARNING:** Failure to insert the seat post until the min insert line is covered may result in serious injury or death.



Seat post correctly inserted.



Tighten the thumbscrew.



Unfold the pedals by pulling the lever and lifting the pedal into position.

## 2.4 Adjustments

### 2.4.1 Adjusting the Saddle Height



Locate the hex key under the saddle.



Remove the hex key from the tool holder.



Loosen the seat-post bolt using the hex key as shown.



 **CAUTION:** Do not exceed the minimum insertion mark on the seat post. The minimum insertion mark must not be visible.



Adjust the saddle to the appropriate height. Tighten the seat-post clamp to 5-6 Nm.

## 2.5 Front and Rear Reflectors

Front and rear reflectors are supplied as standard with your Gocycle. The Front Reflector can be found in the small parts bag. The Rear Reflector is pre-installed under the saddle.



**WARNING:** Reflector angles and mounting positions may vary from region to region. Consult your local regional authority to confirm local requirements.

### 2.5.1 Installing the Front Reflector



Open the reflector bracket as shown.





Place the bracket around the upper stem and tighten, using a screwdriver, to secure as shown.



Mount the front (white) reflector onto the bracket as shown. Ensure that the reflector is completely engaged with the bracket.



Adjust the bracket to ensure that the reflector is vertical and tighten the bolt to 4-6 Nm.



## 2.5.2 Rear Reflector



The rear reflector is pre-installed under the saddle.

 **CAUTION:** Ensure that clothing does not cover the reflector when riding, for example a long jacket or coat or carrier bag or backpack. If in doubt, ask a friend to see if the reflector is visible from all appropriate angles while you are riding.



### 3 CHARGING YOUR GOCYCLE

#### 3.1 Getting to Know Your Gocycle Lithium-ion Battery



Part Number	Description
<b>1</b>	Battery Fuel LEDS
<b>2</b>	On/Off Button
<b>3</b>	Battery fuel indicator
<b>4</b>	Charging port
<b>5</b>	Charging port cover



### 3.2 Checking Your Battery Charge Level

The battery charge level will show on the dashboard display during riding.

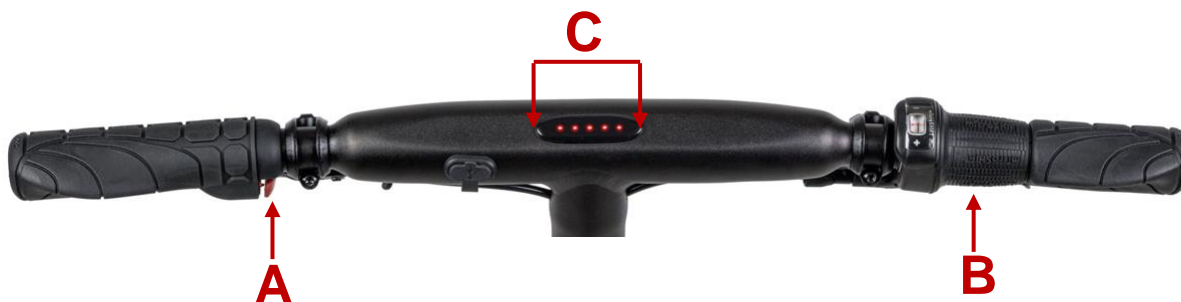

<b>A</b>	Boost Button
<b>B</b>	Mechanical Gear Selector
<b>C</b>	Battery charge indicator

The battery charge level is displayed in area C, shown above. Each LED represents approximately 20% of battery charge, with 5 LEDs = 100%, 3 LEDs = 60% etc.

During riding when using the motor, the battery charge level will decrease over time, with fewer LEDs displayed accordingly. The Battery Low Level Indicator is represented by one flashing LED. When this is displayed, the Gocycle will default to Power Save mode. See [Power Save Mode](#) for more information.



### 3.3 Charging the Gocycle Battery

#### 3.3.1 Charging the Battery inside the Gocycle Frame



Open the rubber charging port cover, as shown.



Insert the charging lead as shown.



Plug the power lead into the mains electricity supply and turn on (where applicable).



The charger light will turn red to indicate charging. The charger supplied with the Gocycle G4, G4i and G4i+ is the 36V 4A Fast Charger which will take approximately 3.5 hours to fully charge an empty battery.



When the battery is fully charged (5 LEDs showing on the dashboard display or 100% on the GocycleConnect App), turn off the mains electricity (where applicable).



Remove the charging lead and replace the rubber charging port cover.



BEST PRACTICE! With the battery fully charged and the charger disconnected, turn the battery off. Hold for ½ seconds or more before releasing. See section [Q](#) for more information.

In any event, leaving the Gocycle on charge continuously for more than 24 hours is not recommended.



Replace the charger port cover.

**⚠ WARNING:** Ensure that the rubber charging port cover is securely in place before riding. Failure to do this could result in your battery being compromised by water and your warranty being invalidated.



### 3.3.2 Charging the Battery outside of the Gocycle



Turn off the battery by pressing and holding the on/off button. Hold for ½ seconds or more before releasing.

**⚠ WARNING:** Do not attempt to remove the battery from the frame while the battery is switched on



Press in the red latch lock whilst pulling the latch open as shown.



Fold the frame.





Fold the Gocycle so the wheels are next to each other.



Press the red latch lock and open the latch.



Fold the handlebars.



Hook the fold strap to the handlebar hook as shown.

 **CAUTION:** Ensure that the fold strap is secure before attempting to remove the battery.



Remove the detent pin as shown.



Open the latch as shown.



Lift the battery ring as shown.



Turn the ring 180° as shown so that the battery ring is at the bottom. This releases the battery from the frame.



Pull robustly in a downwards direction as shown.

**CAUTION:** The battery can unexpectedly slide out of the frame. Use extreme caution to avoid damaging the battery or injury. We recommend using both hands to steady your pulling force against the battery and the frame.



Support the battery and remove from the frame as shown.



Plug the charger jack into the charge port as shown.

**WARNING:** Charge the battery in a dry indoor room fitted with a smoke detector and preferably on a raised surface where there is not possibility of flooding.



Plug the charger into mains electricity supply and turn (on where applicable).



The charger light will turn red to indicate charging. The charger supplied with the Gocycle G4, G4i and G4i+ is the 36V 4A Fast Charger which will take approximately 3.5 hours to fully charge an empty battery.



When the battery is fully charged (5 LEDs showing on the dashboard display or 100% on the GocycleConnect App), turn off the mains electricity (where applicable).



BEST PRACTICE! With the battery fully charged and the charger disconnected, turn the battery off. See section [Battery on/off button](#) for more information. In any event, leaving the Gocycle on charge continuously for more than 24 hours is not recommended.

With the battery turned off, insert the battery into the frame as shown.

**⚠ WARNING:** Ensure that the battery is switched off before inserting into the frame.

Push the battery up, into the frame. There will be some resistance as the battery connectors engage.



Twist the battery ring to between 90° and 180° to engage the tab behind the frame.



Stow the blue ring as shown.



Reassemble the frame latch ensuring that the detent pin is fully engaged in the position as shown.



Ensure that the Frame Detent Pin is fully inserted and the head is flush with the bracket.



Close the frame latch as shown. The latch should begin feel tight between 45mm and 55mm from the fully closed position. See Adjusting the Frame Latch.



Check the latch is closed.

**⚠ WARNING:** Ensure that the red latch lock is visible and engaged with the frame as shown. If the red latch lock is not visible as shown or is not engaged with the frame, do not ride the Gocycle. Contact your local Gocycle dealer or contact us through [gocycle.com/support](https://gocycle.com/support) for support. Failure to check the latch is locked may result in serious injury or death.





Push hard on the latch in the direction shown to confirm that the latch is locked. Check latches are locked. Latch should not open when pushed hard in direction shown.

**⚠ WARNING:** Failure to check latch is locked may result in serious injury or death.



With the black latch closed and using only one finger, press and release the red latch lock multiple times.

- The black latch should not open and the red latch lock should remain engaged and “hooked/locked” into the frame or handlebar when released.
- The red latch lock should move freely with minimum force and it should spring back fast and sharply to the fully locked position.
- The red latch lock should not stick or squeak or freeze and it should not have a slow, partially closed or delayed action.



**⚠ WARNING:** A Gocycle with fold latches that does not pass this important safety check poses a risk of injury and must not be ridden.



## 4 OPERATION

### 4.1 Battery on/off button

#### 4.1.1 Switching the Battery On (Wakes up the Battery for Use)

The battery must be switched on before you can use your Gocycle. If the battery is not switched *on*, the Gocycle G4 motor and Bluetooth to connect to your smart phone will not function.

To switch the battery on for use:



Tap the button once (less than ½ a second). This will turn on the battery.



When the Gocycle is ON, the dash will illuminate and show the current battery life. Each LED on the left side of the dash represents 20% of battery life.



### 4.1.2 Switching the Battery Off

If no motor activity is detected by the Gocycle, the battery will turn off automatically after approximately 30 minutes.



To turn the battery off, press and hold the button for ½ a second or more. The LEDs on the dash and the LEDs on the rear of the battery will turn off.

### 4.1.3 Automatic battery turning off

The battery will turn off automatically after 30 minutes of no motor activity.

## 4.2 Familiarising Yourself with Gocycle Dashboard Display

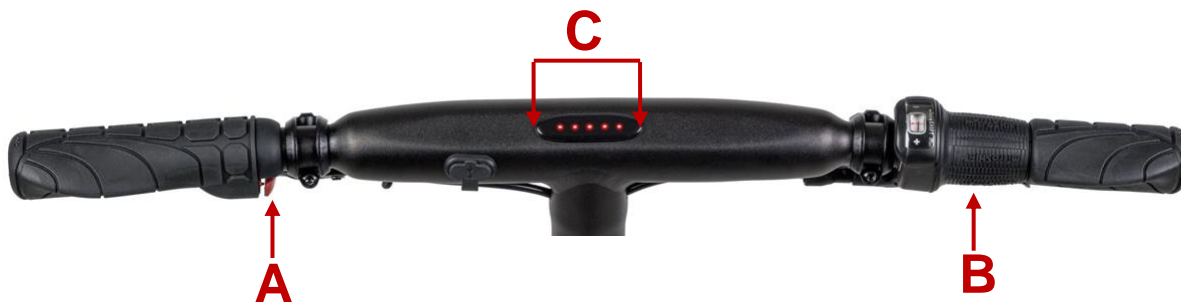

<b>A</b>	Boost Button
<b>B</b>	Mechanical Gear Selector
<b>C</b>	Battery charge indicator



## 4.3 Pre-Registration: Factory State and Delivery State Explained

### 4.3.1 Factory State – Direct from Gocycle

If Gocycle has been shipped directly from Gocycle it will be in *Factory State* and requires registration via the GocycleConnect App for full functionality.



Pre- Registration: Delivery State	
Dashboard Display	3 LEDs
LEDs Indicate	Gocycle is in Factory State
Motor Restricted?	Motor will not operate

### 4.3.2 Delivery state – From a Gocycle Dealer

If a Gocycle is bought or shipped from a dealer it is in *Delivery State* and will require registration via the GocycleConnect App to gain full functionality.

*Delivery State* allows 60 miles (100 km) of normal usage before the motor will cease to operate. You must register your Gocycle within this distance to remove the restriction and avoid loss of motor function.

### 4.3.3 After Registration: Normal Operation

When stationary and not in use for more than 60 seconds, the dashboard will display scrolling LEDs. This is a screensaver and the Gocycle is in *Standby*.



After Registration: Normal Operation	
Dashboard Display	LEDs "SCROLLING" back and forth
LEDs Indicate	Screensaver – Gocycle in <i>Standby</i>
Motor Restricted?	No restriction



## 4.4 Brakes

The Gocycle is equipped with front and rear hydraulic disk brakes, operated by two levers on the handlebars (shown below). Before riding, it is important to familiarise yourself with which brake lever operates the front brake and which lever operates the rear brake. Proper use of your brakes will slow and bring your Gocycle to a safe and controlled stop.



## 4.5 Shifting

### 4.5.1 Shifting Gears

Your Gocycle comes fitted with rotary microshift shifting control.



### 4.5.2 Shifting Internal Gear Hub Gears

Shifting with an internal gear hub drivetrain is simply a matter of rotating the shifter to the indicated position for the desired gear ratio. After you have rotated the shifter to the gear position of your choice, ease the pressure on the pedals for an instant to allow the hub to complete the shift.



### 4.5.3 Which Gear Should I be in?

The numerically lowest gear (1) is for the steepest hills. The numerically largest gear is for the greatest speed.

Shifting from an easier, “slower” gear (like 1) to a harder, “faster” gear (like 2 or 3) is called an upshift. Shifting from a harder, “faster” gear to an easier, “slower” gear is called a downshift. It is not necessary to shift gears in sequence. Instead, find the “starting gear” for the conditions — a gear which is hard enough for quick acceleration but easy enough to let you start from a stop without wobbling — and experiment with upshifting and downshifting to get a feel for the different gears. At first, practice shifting where there are no obstacles, hazards or other traffic, until you’ve built up your confidence. Learn to anticipate the need to shift, and shift to a lower gear *before* the hill gets too steep. If you have difficulties with shifting, the problem could be mechanical adjustment. See your Gocycle dealer for help.

### 4.5.4 What if it won’t Shift Gears?

If moving the shift control one click repeatedly fails to result in a smooth shift to the next gear, chances are that the mechanism is out of adjustment. Contact your Gocycle dealer or Gocycle for further assistance.

The internal 3-speed Shimano Nexus hub gear is controlled by a Micro shift mechanical shifter. Due to the shifting mechanism of an internal hub gear it is best practice to ease off the pedals or coast when shifting gears.

## 4.6 Mini Dash

The LED mini dash display on the handlebars displays the current battery capacity. A single LED represents approximately 20% of the battery capacity.



## 4.7 Boost Button

When the boost button is located on the underside of the left-hand grip. When the boost button is pressed and held the using your left thumb, the Gocycle will provide full motor assist if the pedals are turning. If the Gocycle is configured and being used in a region that allows the use of a throttle, the boost button can be held and pedalling is not required for motor assistance.



## 4.8 Riding Modes

You can operate your Gocycle in different pre-set modes or generate a custom mode to suit your personal riding style with the GocycleConnect app.

### 4.8.1 Riding Modes Reference Table

Mode Name	How to Start Motor	How to Stop Motor	Continuously Press and hold the boost button to Operate the Motor	Pedal Input Controls Motor Power	Press and hold the boost button for Full Motor Assist	Power Save Mode
<i>City</i>	Light pedal effort	Stop pedaling or reduce pedal effort	X	✓	✓	Motor will not operate unless boost button is pressed
<i>Eco</i>	Medium pedal effort	Stop pedaling or reduce pedal effort	X	✓	✓	Motor will not operate unless boost button is pressed
<i>On Demand</i>	Pedal + press boost button	Stop pedaling or release selector	✓	X	✓	Motor will not operate unless boost button is pressed
<i>City+</i>	Light pedal effort with progressive assist	Stop pedaling or reduce pedal effort	X	✓	✓	Motor will not operate unless boost button is pressed
<i>Custom</i>	Customizable via App (see <a href="http://www.gocycle.com/support">www.gocycle.com/support</a> for more information)					

### 4.8.2 Selecting a Riding Mode

Refer to the table in 4.8.1 Riding Modes Reference Table.

By using the GocycleConnect app you can operate your Gocycle in different modes to suit your personal riding style. The motor assistance will start and stop at different speeds - you can control this by either pressing the boost button or rider pedal input, or a combination of both. See below for more information.



 **WARNING!** Do not attempt to change a riding mode whilst in motion. Attempting to change the mode whilst riding will severely impair rider concentration and will dramatically increase the chance of an accident, which may result in injury to the rider or even death.

### 4.8.2.1 City Mode

*City* mode utilises your Gocycle’s torque sensor, with the motor assistance level controlled by rider pedal input. (Hard pedalling = high motor assistance, soft pedalling = less motor assistance).

In this mode, within the motor operating speed and whilst the rider is providing pedal input, the motor will start automatically and will continue to operate until the maximum speed is reached.

For maximum motor assistance, press and hold the boost button.

Above the maximum motor speed, the motor will stop. There is no need to press and hold the boost button. When the pedals cease to rotate or with reduced pedal input, the motor will stop.

 **WARNING!** The motor will continue to operate while the rider exerts pedal effort and is travelling within the motor operating speed. To stop the motor, cease pedalling, or reduce pedal effort.

Mode	<i>City</i>
Boost Button	No need to hold
Pedals	Control motor assistance level—must be turning
Motor Start	<b>Light</b> pedal effort
Maximum Motor Assistance	<b>Medium</b> pedal effort, or press and hold the boost button
Top Speed (Motor Cut-Out Speed)	EU EPAC - Up to 15.5mph (25km/h) North America Type 1 and Type 2 - Up to 20mph (32km/h)

### 4.8.2.2 Eco Mode

*Eco* mode operates in the same manner as *City* mode, but the rider must pedal harder to gain assistance. Use this mode if you wish to conserve your battery and increase your range.

In this mode, within the motor operating speed and whilst the rider is providing pedal input, the motor will start automatically and will continue to operate until the maximum speed is reached.

For maximum motor assistance, press and hold the boost button.

Above the maximum motor speed, the motor will stop. There is no need to press and hold the boost button. When the pedals cease to rotate or with reduced pedal input, the motor will stop.

 **WARNING!** The motor will continue to operate while the rider exerts pedal effort and is travelling within the motor operating speed. To stop the motor, cease pedalling, or reduce pedal effort.

Mode	<i>Eco</i>
Boost Button	No need to hold
Pedals	Control motor assistance level—must be turning





Motor Start	Medium pedal effort
Maximum Motor Assistance	High pedal effort, or rotate and hold the boost button
Top Speed (Motor Cut-Out Speed)	EU EPAC - Up to 15.5mph (25km/h) North America Type 1 and Type 2 - Up to 20mph (32km/h)

### 4.8.2.3 On Demand Mode

In *On Demand* mode, the rider can choose whether or not to have motor assistance. Select this mode if you wish to ride the Gocycle without motor assistance—and have assistance when required by pressing the boost button.

In *On Demand* mode, within the motor operating speed and whilst pedalling, press and hold the boost button to start and maintain motor assistance. The motor will continue to operate until the maximum speed is reached, or until the pedals cease to turn or until the boost button is released. When the pedals cease to rotate or the boost button is released, the motor will stop.

Note: Relying heavily on the motor assistance will dramatically reduce the range of your battery and increase the wear on your motor drive components. See [Maximizing Your Gocycle's Motor Performance and Reliability](#) for more information as to how to get the best out of your Gocycle.

 **WARNING!** In EPAC and North America Type 1 the motor will continue to operate while the boost button is pressed and the pedals are rotating. To stop the motor, cease pedalling or release selector A

In North America Type 2 the motor will continue to operate while the boost button is pressed and the pedals are rotating. To stop the motor, release selector A (North America Type 2).

Mode	<i>On Demand</i>
Boost button	Press and hold for motor to operate
Pedals	Must be turning for motor to operate
Top Speed (Motor Cut-out Speed)	EU EPAC - Up to 15.5mph (25km/h) North America Type 1 and Type 2 - Up to 20mph (32km/h)

### 4.8.2.4 Custom Mode

Custom mode is enabled when one of the preset modes (City, Eco or On Demand) are modified. Once a mode has been modified it will need to be synced to the Gocycle manually.

Above the maximum motor speed, the motor will stop. There is no need to press the boost button. When the pedals cease to rotate or with reduced pedal input, the motor will stop.

Mode	<i>Custom</i>
Boost Button	Customisable via Gocycle App
Pedals	For more information, please visit <a href="http://www.gocycle.com/support">www.gocycle.com/support</a>
Motor Start	
Maximum Motor Assistance	
Top Speed (Motor Cut-Out Speed)	EU EPAC - Up to 15.5mph (25km/h) North America Type 1 and Type 2 - Up to 20mph (32km/h)



*Custom* mode enables a rider to edit various mode settings including;

- Pedal effort required for motor to start
- Pedal effort required for maximum motor assistance
- Maximum speed
- Pedalling required for motor assistance ON/OFF (Not enabled for EPAC)

Gocycle is Bluetooth® enabled and requires the GocycleConnect app to connect via a smart device. The user can personalize the settings via the App and save the settings to suit the user's riding style and assistance preferences.

For more information, please visit [www.gocycle.com/support](http://www.gocycle.com/support) or contact your local reseller.



**WARNING!** Depending on your region, certain Gocycle settings may or may not be available.

Consult your local transport authority for information on legal restrictions.

#### 4.8.2.5 Gocycle G4 Power Save

Your Gocycle G4 will default to *Power Save* when the battery has reached a low level. This is after the dash displays shows one (1) LED.

All riding modes will default to *Power Save* mode when a low battery level is reached.

In the event that you enter *Power Save* mode, the motor will operate at a reduced power only when the boost button is pressed and the pedals are turning. If the pedals cease to turn, or the boost button is released, the motor will stop.

If you continue to ride in *Power Save* mode, the motor will cease to operate but 1 LED will remain illuminated indicating that the Gocycle is switched on.



**WARNING!** If you have ridden your Gocycle at a low voltage, in *Power Save* mode, charge your battery within 12 hours. Failure to do so may result in permanent damage to your battery and will void your warranty.

## 4.9 Maximising Your Gocycle's Motor Performance and Reliability

Gocycle's electric motor is designed to assist your pedal input. It is not designed for the motor power to be the sole means of propulsion.

As with a car, top speed and range (related to fuel consumption) are difficult to define as both factors are greatly affected by a large number of variables. For the Gocycle, this includes but is not limited to rider weight (including clothing and luggage), tire type, tire pressure, terrain, surface texture, wind and weather conditions and of course, how much pedal input the rider is providing. Note: battery range can be severely impacted by cold temperatures (less than 10 deg C).

Continual use of the motor assistance whilst riding and/or selecting a mode with a higher top speed will have a negative effect on the range of your battery. Using the motor assistance sparingly with maximum rider pedal input will ensure the best possible range.

To get the best out of your Gocycle, read the following points carefully:

1. *Pedalling*: We recommend that for the best performance you continue to pedal at all times.



The motor should be used to “top-up” or “boost” power. Not providing pedal input (where a riding mode allows) will dramatically reduce battery range.

2. *Excess weight:* Where possible, try to keep the total combined weight of clothing, luggage and accessories to a minimum. Overloading a Gocycle will reduce the battery range. Overloading will also affect your Gocycle’s handling and increase the stresses on the clutch, gearbox and motor, potentially reducing the service life of the product.
3. *Tires:* Ensure the tires are correctly inflated. See 5.7 Tires for more information.
4. *Riding style:* Where rough terrains (e.g., poor road surfaces, potholes, speed bumps, etc.) are unavoidable, you should adapt your riding style accordingly.



**WARNING! Never use the motor when passing over obstacles such as ruts in the road or speed bumps, etc. Doing so will increase the stresses on the drive components and will reduce the service life of the product, possibly invalidating your warranty.**

5. *Deceleration/braking:* Do not use motor power whilst decelerating or braking. Consciously using the motor assistance only when required will ensure the maximum possible battery range.
6. *Wet conditions:* Gocycle is a British product, designed with British weather in mind. However, it is important that your Gocycle is dry before storage. A city atmosphere can be a corrosive environment made worse with high humidity. We recommend a simple check and towel-down (if necessary) after using your Gocycle in wet conditions. See 5.4 Cleaning and Preventing Corrosion.



## 4.10 Motor

### 4.10.1 Heat

Compared with traditional ebike motors, Gocycle's motor is more compact and lightweight. While this design offers benefits, certain drawbacks exist—specifically, the motor can get hot.

Gocycle's motor will get hot under normal operation similar to the exhaust pipe or engine of a motorcycle or moped.



 CAUTION! During and shortly after use, the motor area (highlighted) will be hot to touch!

 CAUTION! Extreme caution should be used when attempting to touch any part of the motor after it has been in operation—the same caution you would use in the kitchen with hot pots or pans or boiling water. We recommend that you do not attempt to touch the motor unless it has been switched off for at least five minutes.

### 4.10.2 Over-Temperature Protection

The motor and controller are automatically protected against over-temperature operation. If the temperature of the motor or the controller gets too high, the power will be gradually reduced to prevent damage to these components. You may experience this condition for example riding up long steep hills while using full motor assistance. When over-temperature protection is in effect, the power available to the motor will be reduced. When the temperature of the motor and/or controller has cooled adequately, full power will again be available.



## 4.11 Folding

### 4.11.1 Folding the Gocycle



Press in the red latch lock whilst pulling the frame latch open as shown.



Undo the seat post clamp.



Remove the seat post.



Whilst pressing the red latch lock, pull the handlebar latch open as shown.



Fold the handlebars as shown.



Press in the red latch lock whilst pulling the frame latch open as shown.



Fold the frame so that the wheels are touching as shown.



Unhook the fold strap from the Lockshock pin.



Attach the fold strap to the handlebar hook as shown.



Unclip the saddle multi-tool as shown.



Open the fold strap and insert the seat post.

**⚠ CAUTION:** Take care not to touch the frame when inserting the seat post through the fold strap and into the seat post collar. Failure to do so may result in scratches to the frame.



Align the saddle multi-tool with the seat post collar.





Insert the saddle multi-tool into the seat post collar as shown.



Pull the fold strap toggle towards the seat post.



Folded Gocycle.



### 4.11.2 Storage Strap

When storing or transporting (including lifting) the Gocycle in its folded state, the storage strap must be used in conjunction with the fold strap. This ensures that the wheels are securely held together during lifting and handling. We strongly recommend that the storage strap is fitted at all times when the Gocycle is in a folded position whilst small children have access to the Gocycle.

The storage strap prevents the wheels from being pulled apart or the frame opening accidentally during lifting and handling which could lead to injury.



**⚠ WARNING:** The storage strap must be fitted when lifting, storing or transporting the Gocycle.

### 4.11.3 Rolling

When folded, the Gocycle can be manoeuvred on the two wheels by holding the saddle.



To roll the Gocycle place your foot behind one of the wheels and pull the saddle towards you.



The Gocycle can only be rolled forwards. Never roll the Gocycle backwards.

**CAUTION!** Take care when rolling the folded Gocycle. Practice rolling and handling the Gocycle before attempting to take it on public transport. Do not wheel the Gocycle backwards.



We do not recommend folding the kickstand by hand. If you choose to do so, the springs in the kickstand are very strong. Use extreme caution to avoid injury.

**CAUTION!** Take care when folding the kickstand by hand. There is a risk of injury.



When you have finished rolling the Gocycle, place a foot behind the wheel and pivot the Gocycle forwards so that it rests on the kickstand and wheels.



## 4.12 USB-C Port

There is a USB-C Port on the right hand side of the dash under a rubber cover.

It is designed to charge small electronic devices and outputs 5V at 1.5A.



USB-C Port covered



USB cable inserted.

**⚠ CAUTION!** Do not ride the Gocycle while using the USB-C port. There is a risk of injury.



## 5 MAINTENANCE AND ADJUSTMENTS

### 5.1 Maintenance and Service

Contact your nearest Gocycle dealer for service and maintenance. A list of approved dealers can be found at [www.gocycle.com/store-locator](http://www.gocycle.com/store-locator). Before attempting any maintenance on your Gocycle you must visit [www.gocycle.com/safety](http://www.gocycle.com/safety) for up to date and important safety related information such as Technical Bulletins and the latest Owner's Manual.



**WARNING:** You must perform regular visual inspections of your Gocycle and perform any recommended adjustments and maintenance in order to ensure that your product is safe to ride.

Please visit [www.gocycle.com/safety](http://www.gocycle.com/safety) and review any important Technical Bulletins and safety information relating to your Gocycle model. You should also download and review the latest Owner's Manual from [www.gocycle.com/safety](http://www.gocycle.com/safety). Please note the recommended inspection and service intervals below.

### 5.2 Service interval

Recommended Service Interval	Performed By	Distance Ridden	Time
Pre-Ride Checklist	Owner	Before each ride	Before each ride
Visual Inspection / Service if required	Owner or Authorized Gocycle Reseller (recommended)	After first 100 miles/160 kms	2 months after first ride
Visual Inspection	Owner	Every 500 miles/800 kms	Every 3 months
Visit <a href="http://www.gocycle.com/safety">www.gocycle.com/safety</a>	Owner		Every 3 months
Check and Update to latest Firmware Version	Owner		Every 3 months
Visual Inspection / Service recommended	Owner or Authorised Gocycle Reseller (recommended)	Every 2000 miles/3200 kms	Annually



### 5.3 Visual Inspection Guide – (Every 3 Months/500 Miles)

The following information details mandatory inspection points to be completed every 3 months/ 500 miles (whichever is sooner) of Gocycle ownership. This is to ensure your Gocycle is safe to ride and operating at peak performance. If you find any of the following items to be damaged or incorrectly adjusted then please seek immediate assistance from your nearest Authorized Gocycle Service Centre who will help to rectify any issue. Do not adjust fixtures without first consulting the Owner's Manual or your Authorized Gocycle Reseller to ensure the correct adjustment is made. Incorrect adjustment could lead to failure of a component.

As with a conventional bicycle, your Gocycle will not last forever. It is a mechanical item that under normal riding will be stressed, and eventually the parts will fatigue, cracks will develop and it will become unsafe to ride. The number of miles of riding a bicycle will endure cannot be predicted since there are many variables that affect product life including:

- Rider weight
- Riding style
- Tire pressure and type
- Roughness of the road
- Whether or not the bicycle has been crashed or damaged in transit
- Whether or not the bicycle has been ridden over large bumps such as potholes or curbs
- The amount and weight of luggage carried
- The speed at which it has travelled
- Whether it has been subject to abuse or vandalism
- Time of exposure to ultraviolet radiation from the sun
- Storage conditions, such as ambient temperature and moisture levels

Responsible, safe riding and regular maintenance, such as within the guidelines of this manual, should afford many thousands of miles of operation of your Gocycle. Nevertheless, you must inspect the Gocycle every 500 miles to see if any of the components have cracks and need replacing. To do this, clean the Gocycle thoroughly with a damp cloth. Wipe away all dust or dirt. Look carefully at all the components under good lighting.



**WARNING:** Failure to inspect the Gocycle thoroughly may have serious consequences and could result in serious injury or even death.

**IMPORTANT:** Check [www.gocycle.com/safety](http://www.gocycle.com/safety) for up to date Technical Bulletins that might affect your Frame Number.

NOTE: More frequent servicing may be required for Gocycles used in adverse conditions or with a more aggressive riding style.

1. Inspecting for cracking and fatigue failures.
2. Inspection of Disc Covers for damage (Front and Rear).
3. Hub Cap in position to prevent excessive dust contaminating Hub Gear.
4. All Cleandrive magform bolts present x 12, 4-6Nm (one located at front of Cleandrive - check by folding).



5. Pivot block magform bolts present x 5, 4-6Nm and no cracks present.
6. Check pedals are tight, 35-40Nm.
7. Check crank bolts are tight, 35-40Nm.
8. Check operation and closing of the stem latch which should start to feel tight between 25mm-35mm. Check that the red latch lock moves freely on its spring and engages with the stem when the latch is locked.
9. Check operation and closing of the frame latch which should start to feel tight between 45mm-55mm. Check that the red latch lock moves freely on its spring and engages with the frame when the latch is locked.
10. Check the 5x PitstopWheels screws are present and tight, 4-6Nm. Front and Rear.
11. Check stem adjuster bolts and top hats are present and tight, 7-8Nm.
12. Check that headset is not loose. (Section [6.12 for adjustment](#)).
13. Check hub gear for excessive movement – (conducted after confirming all PitstopWheel screws are tight) (Section [6.14 for adjustment](#)).
14. Check both brakes are operating correctly and levers cannot be pulled to the handlebar.
15. Check the latch lock holes in the frame and the stem (15a and 15b) are not worn and that the latch lock engages robustly when the latches are fully closed and locked.
16. Check and remove any dust or dirt from the shear pin holes.
17. Ensure the Gocycle firmware is up to date. Go to Settings in your GocycleConnect App and scroll down to Firmware. Update the firmware if a new version is available.
18. Check stem hinge bolts are present and tight. Using 2x 4mm hex keys check the torque, 4-5Nm.
20. Turn off battery and remove from the frame:
  - a. Inspect the exterior of the battery.
  - b. Inspect the connectors and area surrounding the connectors.
21. Check red latch locks, for more information check the links below
  - c. GX and GXi Latch Maintenance- <https://gocycle.zendesk.com/hc/en-us/articles/360010685697-GX-and-GXi-Latch-Maintenance>
  - d. Tech Bulletin 23: Safety Check - (GX / GXi) Fold Latch Function - <https://gocycle.zendesk.com/hc/en-us/articles/360010699157>



**WARNING:** Should you discover a fatigue crack more than 3mm long, or should you suspect that a component may have received an impact in an unusual way—such as if the product has been dropped — do not ride your Gocycle and immediately contact us through [gocycle.com/support](https://gocycle.com/support).









## 5.4 Cleaning and Preventing Corrosion

We do not recommend that you ride your Gocycle in heavy rain or store it in damp or wet areas. If you do find yourself riding while it is raining, we recommend that you use the motor when safe to do so. Using the motor will allow heat to build up in the motor and the electronics which will evaporate water if present from these components.

Water and moisture (especially spray from roads that are salted to reduce the formation of ice) can accelerate corrosion (rust) of the various metallic components on the Gocycle. This will reduce the life of product. Leaving water and moisture on the Gocycle could also result in failure of the electronics, battery or motor system. The warranty will not cover failure as a result of corrosion through neglect.

Here are some best practice recommendations:

- If your Gocycle has water on it, we recommend that you wipe it dry as soon as possible with a towel or dry cloth.
- The less you expose your Gocycle to moisture or water, the longer it will last.
- We do not recommend that you store your Gocycle outside. Keep your Gocycle inside your house, flat or garage.
- If you wish to clean the Gocycle, we recommend that you use a damp towel or cloth and mild liquid soap. First wipe down all areas with a damp towel, then wipe dry with a dry towel. Alternatively, your local bike shop can recommend a suitable spray bottle bike frame cleaner.



**WARNING:** Keep your Gocycle clean and dry at all times where possible. Never spray the Gocycle with a hose or high-pressure cleaning system. Never use polishes, waxes or solvents to clean your Gocycle. Never use polish on the tires – EVER!

## 5.5 Lubrication



### 5.5.1 Cleandrive

There is no need to regularly inspect, clean and lubricate the internal components of the Cleandrive®

The gearbox, rear hub, hub bearings and chain drive system (Cleandrive) are lubricated during production, and unless the Gocycle is regularly exposed to a high-humidity, corrosion-enhancing environment, or flooding, these components will last the lifetime of the product and it is not necessary to open the Cleandrive to lubricate any components.



## 5.5.2 Lockshock

From time to time and particularly during periods of hot or abnormal weather, your Lockshock™ may require additional lubrication to prevent undesired noises whilst riding such as squeaking. The Gocycle Lockshock™ is delivered pre-greased from the factory however certain riding conditions or environments can, over time, remove some of this grease. Re-lubricating of the Lockshock™ should be completed as part of your regular maintenance to reduce the likelihood of developing noises when riding.

As part of regular maintenance or in the event that your Gocycle Lockshock™ develops a noise whilst riding, the Lockshock™ can be lubricated using a suitable silicone lubricant. With the Gocycle supported, remove the Fold Strap Assembly and rotate the Lockshock™ so that it is pointing upwards. Be sure to have a cloth ready to remove any excess silicone lubricant.



Spray a generous amount of silicone lubricant down into the end of the Lockshock™ and remove any overspray or spillages with a cloth. Wait 5 minutes with the Lockshock™ in the upright position so that the lubricant can disperse downwards. Re-insert the Lockshock plunger and Fold Strap Assembly to complete.



Wait 5 minutes

## 5.5.3 Front and back adjustment.

The saddle can be adjusted forward or back to help you get the optimal riding position on the bike. Ask your Gocycle dealer to set the saddle for your optimal riding position and to show you how to make this adjustment. If you choose to make your own front and back adjustment, make sure that the clamp mechanism is clamping on the straight part of the saddle rails and is not touching the curved part of the rails. Also ensure that you are using the recommended torque on the clamping fastener(s).

## 5.5.4 Saddle angle adjustment.

Most people prefer a horizontal saddle; but some riders like the saddle nose angled up or down just a little. Your Gocycle dealer can adjust the saddle angle or teach you how to do it. If you choose to



make your own saddle angle adjustment and you have a single bolt saddle clamp on your seat post, it is critical that you loosen the clamp bolt sufficiently to allow any serrations on the mechanism to disengage before changing the saddle's angle, and then that the serrations fully re-engage before you tighten the clamp bolt to the recommended torque (Appendix E or the manufacturer's instructions).

 **WARNING:** When making saddle angle adjustments with a single bolt saddle clamp, always check to make sure that the serrations on the mating surfaces of the clamp are not worn. Worn serrations on the clamp can allow the saddle to move, causing you to lose control and fall.

Always tighten fasteners to the correct torque. Bolts that are too tight can stretch and deform. Bolts that are too loose can move and fatigue. Either mistake can lead to a sudden failure of the bolt, causing you to lose control and fall.

Small changes in saddle position can have a substantial effect on performance and comfort. To find your best saddle position, make only one adjustment at a time.

 **WARNING:** After any saddle adjustment, be sure that the saddle adjusting mechanism is properly seated and tightened before riding. A loose saddle clamp or seat post clamp can cause damage to the seat post, or can cause you to lose control and fall. A correctly tightened saddle adjusting mechanism will allow no saddle movement in any direction. Periodically check to make sure that the saddle adjusting mechanism is properly tightened.

If, in spite of carefully adjusting the saddle height, tilt and fore-and-aft position, your saddle is still uncomfortable, you may need a different saddle design. Saddles, like people, come in many different shapes, sizes and resilience. Your Gocycle dealer can help you select a saddle which, when correctly adjusted for your body and riding style, will be comfortable.

 **WARNING:** Some people have claimed that extended riding with a saddle which is incorrectly adjusted or which does not support your pelvic area correctly can cause short-term or long-term injury to nerves and blood vessels, or even impotence. If your saddle causes you pain, numbness or other discomfort, listen to your body and stop riding until you see your Gocycle dealer about saddle adjustment or a different saddle.

## 5.6 Adjusting the Brakes

For information on how to bleed your Gocycle hydraulic brakes, please contact us through [gocycle.com/support](https://gocycle.com/support) or visit your nearest authorised Gocycle dealer.

 **WARNING:** The brakes will increase in power over the first 50 to 100 uses as the pads bed in.

### 5.6.1 Bleeding the Brakes

As with all hydraulic brakes, for the best possible performance, we recommend that the hydraulic brakes on your Gocycle are bled every 12 months. We advise that your Gocycle brakes are bled by a skilled bicycle mechanic with experience with bleeding hydraulic cycle brakes.

**WARNING!** DOT 4 brake fluid can be an irritant when it comes into contact with human tissue. For skin contact, wash off the brake fluid in flowing clean water. For eye contact, the eye area should be flushed with fresh water immediately and continuously for 15 minutes. Consult with medical personnel.



**CAUTION!** DOT 4 brake fluids will strip paint. Exercise caution to avoid brake fluid coming into contact with painted surfaces. If brake fluid does come into contact with painted surfaces, wipe the surface immediately and clean with an isopropyl alcohol.

Dispose of used brake fluid according to local laws.

For additional guidance, consult the manufacturer’s instructions supplied.

## 5.6.2 Replacing the Brake Pads

### 5.6.2.1 Replacing the Front Brake Pads



Locate the 2 brake caliper bolts



Using a 5mm hex key, Loosen and remove bolt bolts

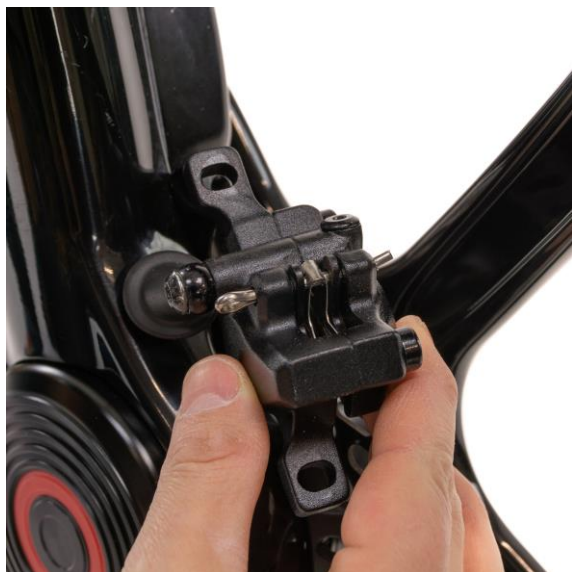

Carefully lift the caliper off of the brake disc.



Compress the split pin using a pair of pliers, as shown.



With the split pin compressed, pull the pin out.

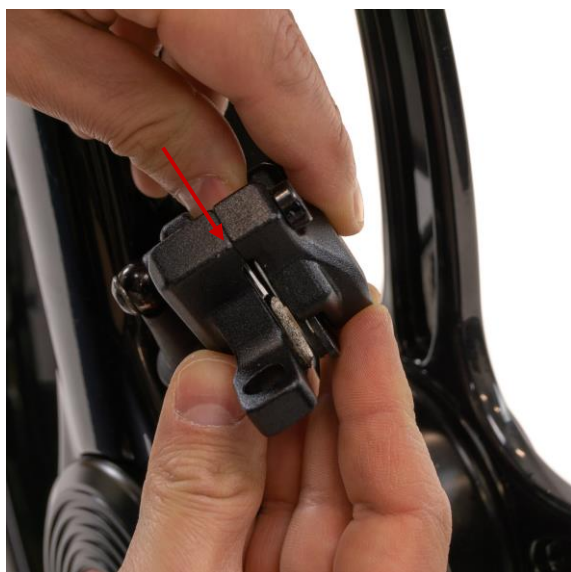

Carefully push the brake pads from the top of the calliper, as shown.

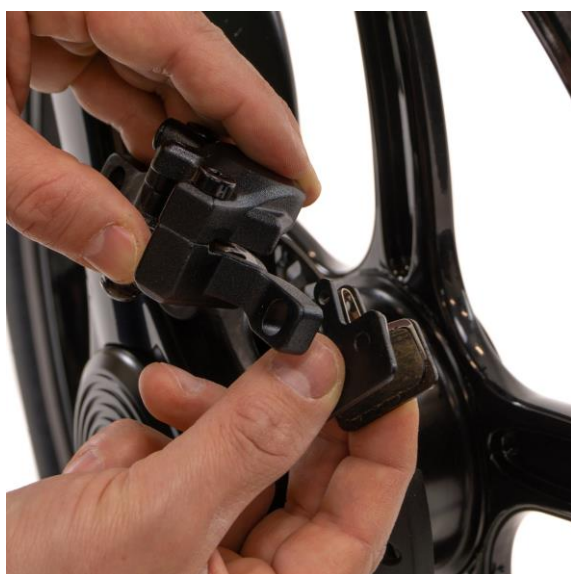

Pinch both brake pads and remove from the calliper.

**⚠ CAUTION:** The pads are sprung. Be careful not to accidentally release the spring



Check and replace the brake pads as necessary before reassembly.



Install new brake pads as necessary. Pinch together with the spring and reassemble into the calliper.

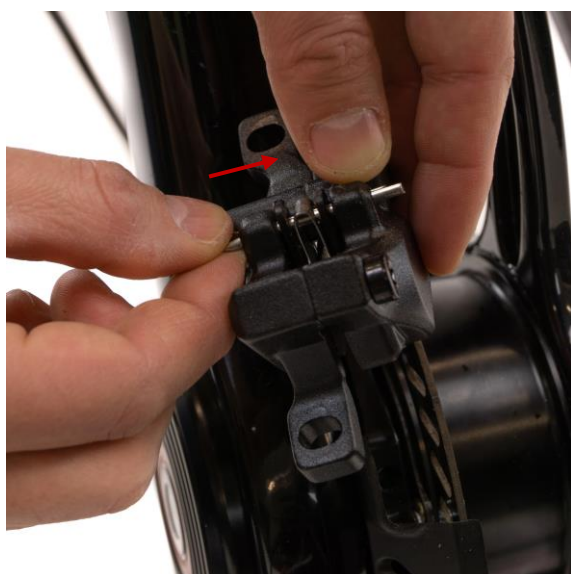

Replace the split pin to secure the brake pads in position.



Using pliers, bend open the split pin to lock it in place.

**⚠ WARNING:** Do not attempt to ride your Gocycle without re-installing the brake pads and securing the split pin.

Doing so may result in injury.





Replace the front brake calliper. Tighten the calliper securing bolts to a torque of 6–8Nm.

Ensure that the brake calliper is parallel to the disk rotor when tightened in order to prevent disk rub.



**⚠ WARNING!** The braking performance of new brake pads will increase over time. Ensure that you “bed-in” your brakes by performing a number of stops.

### 5.6.2.2 Replacing the Rear Brake Pads



Locate and remove the two rear calliper securing bolts, shown.



Compress the split pin using a pair of pliers, as shown.



With the split pin compressed, pull the pin out of the calliper.

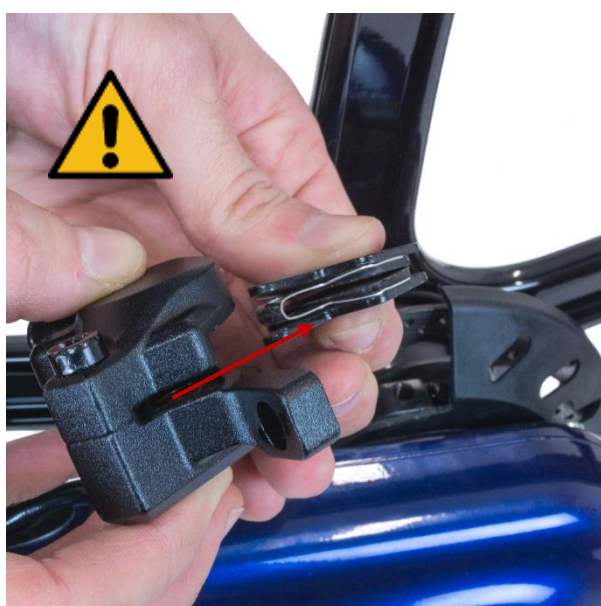

Pinch both brake pads and remove from the calliper.

**⚠ CAUTION!** The pads are sprung. Be careful not to accidentally release the spring



Replace the brake pads as necessary before reassembly.



Replace the brake pads as necessary. Pinch together with the spring and reassemble into the calliper.



Replace the split pin to secure the brake pads in position.

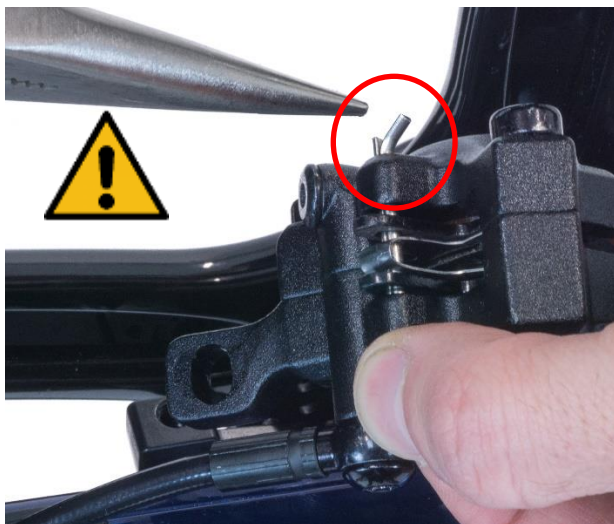

Using pliers, bend open the split pin to lock it in place.

**⚠ WARNING:** Do not attempt to ride your Gocycle without re-installing the brake pads and securing the split pin. Doing so may result in injury.



Replace both calliper securing bolts. Secure to a torque of 6-8 Nm.

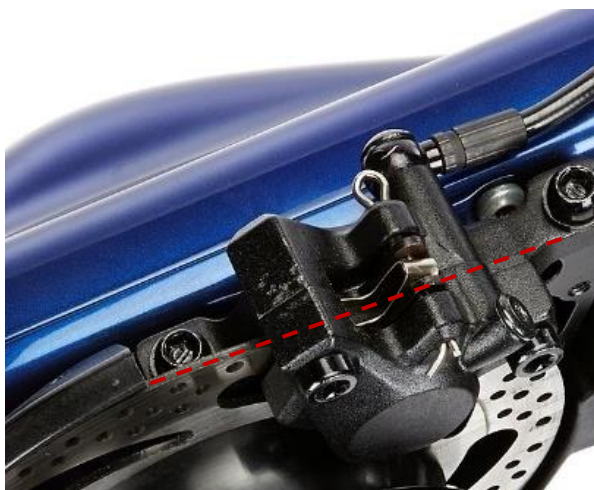

Ensure that the brake calliper is parallel to the disk rotor when tightened in order to prevent disk rub.

**⚠ WARNING:** The braking performance of new brake pads will increase over time. Ensure that you “bed-in” your brakes by performing a number of stops



## 5.7 Tires

### 5.7.1 Gocycle Tire

Gocycle comes fitted as standard with specialised Gocycle tires which are designed to give the best combination of low rolling resistance and puncture resistance in most weather conditions. To maximise performance, we do not recommend that you use any other tires than those supplied with Gocycle.



**WARNING:** The traction or grip level of bicycle tires such as the Gocycle Tire can reduce dramatically in icy or wet road surface conditions. Take special care when riding in icy or wet road surface conditions.

### 5.7.2 Tire Pressures

We recommend that you operate Gocycle with tire pressures of 25-35 psi on the front and 35-40 psi on the rear. This will give the best balance of low rolling resistance and comfort. Running a relatively softer front acts as a “cushioning effect”. Running the front tire at lower pressures than 35 psi can improve comfort and shock absorption at the expense of tire performance, handling, and tire life. Please ensure that you are confident and comfortable with the handling and riding characteristics of the Gocycle if you choose to run lower tire pressures.

Never inflate the tires to more than the stated maximum pressure on the sidewall of the tire. Never exceed 40 psi for any tire on the Gocycle.



**WARNING:** Never inflate any tire on the Gocycle PitstopWheel to more than 40 psi.



**CAUTION:** Operating the Gocycle with a front tire pressure greater than 35psi and/or using the motor assistance on rough terrain, against these recommendations, can reduce the service life of the motor drive system.

### 5.7.3 Changing Tires

When changing a tire, always use plastic tire levers. Never use a metal tire lever as you will damage the wheel rim.

Note the correct direction of the tread of the Gocycle tire in relation to the wheels (see figure below).

The size of the Gocycle rim is generally compatible with BMX-sized tire (406x40-47) from 1.75" to 2.15". Because tire construction and quality vary greatly from manufacturer to manufacturer, we can only recommend that you use Gocycle approved tires as available through the Gocycle webstore.



**WARNING:** Under no circumstances should you ever use “Cargo bike” tires to the Gocycle



**CAUTION:** All warranties will be voided if Cargo bike tires are fitted to the Gocycle at any time during its lifetime.



**⚠ WARNING:** Bicycle tires do not last forever. When the tread depth is critically low and the centreline grooves in the tire have worn down in any part of the tire, it may be dangerous to continue to ride on the tire, and in this event, we recommend that you replace the tire.



Fitting the tires and tire tread orientation.

## 5.8 Adjusting the Headset

From time to time it may be necessary to tighten the headset if it becomes loose. This process is explained by the following steps:



Check for loose headset. There should be no play in the steerer assembly.

Remove front wheel and carefully place Gocycle onto a non-slip surface. Grip the handlebars and rock forwards and backwards to check for any fore-aft movement between the handlebar stem fork assembly and the main frame as shown.

The connection of the handlebar stem fork assembly and the front frame should feel solid and only be free to rotate with respect to the main frame.



Use a 3mm hex key to undo the 2x fork cap and bolts and remove the cap.



Loosen the two fork crown bolts approximately 1-2 turns. Ensure that the front fork and handlebars are able to rotate independently.

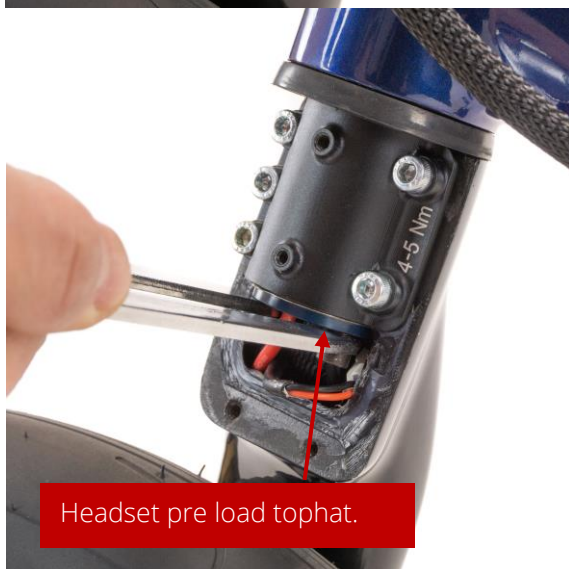

Headset pre load tophat.

Using right angle circlip pliers or a pin spanner, tighten the headset pre load tophat to 4-5Nm.

**⚠ WARNING:** Never tighten or adjust the headset pre load tophat unless the fork crown bolts are loose.



Ensuring that the front fork and handlebars are aligned, tighten the two fork crown bolts to 4-5 Nm.

 **CAUTION:** You will need to recheck both bolts twice to ensure that torque is even between each bolt.



Replace the fork cap and tighten the 2 screws.





## 5.9 Adjusting the Stem Latch



Whilst pressing on the latch lock, open the stem latch in the direction as shown.



Locate the nut and latch pivot pin.



Using a 4mm hex key and an 8mm spanner, loosen the nut and latch pivot pin.

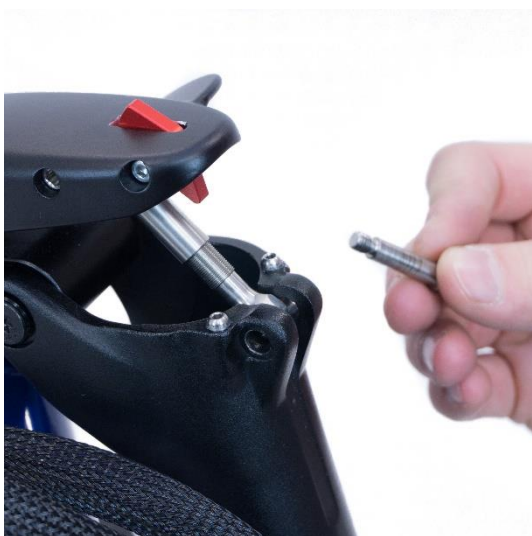

Remove the latch pivot pin.



If the latch is too tight, rotate the latch strut clockwise to shorten the strut by ½ a turn.



If the latch is too loose, rotate the latch strut anti-clockwise to lengthen the latch strut by 1/2 a turn.



Replace the latch pivot pin into the stem and tighten as shown to 3-4 Nm.

Close the stem latch. It should begin to feel tight 25-35mm from the stem. If it does not, repeat the above steps as required.

 **WARNING:** Ensure correct adjustment. Incorrect adjustment may reduce the effectiveness of the latch and latch lock and could reduce the life span of the product or could result in serious injury or death.

Check the latch is fully closed.

 **WARNING:** Ensure that the red latch lock is visible and engaged with the stem as shown. If the red latch lock is not visible as shown or is not engaged with the stem, do not ride the Gocycle. Contact your local Gocycle dealer or contact us through [gocycle.com/support](https://gocycle.com/support) for support. Failure to check the latch is locked may result in serious injury or death.



Push hard on the latch in the direction shown to confirm that the latch is locked. Check latches are locked. Latch should not open when pushed hard in direction shown.

 **WARNING:** Failure to check latch is locked may result in serious injury or death.



### 5.10 Adjusting the Frame Latch

From time to time it might be necessary to adjust the frame latch.



Whilst pressing the red latch lock, pull the latch open as shown.



Open the frame to be able to access the detent pin.



Fold the handlebar as shown and attach the fold strap to the handlebar hook.



Locate the frame latch detent pin as shown.



Press the frame latch detent pin in the direction shown.



Remove the frame latch detent pin.



If the latch is too tight, rotate the latch strut clockwise to shorten the strut by ½ a turn.

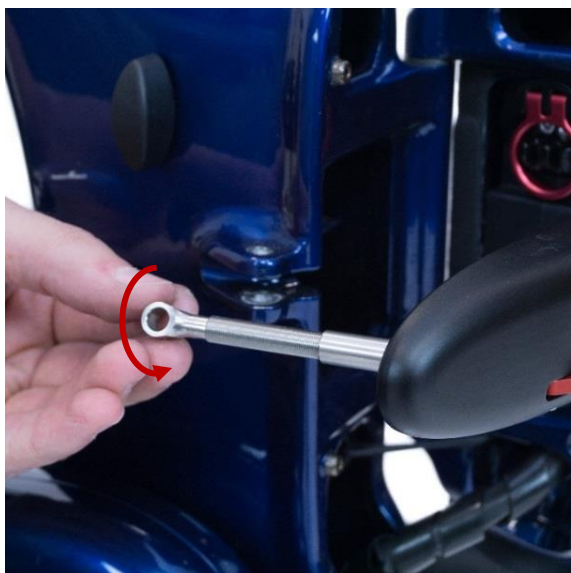

If the latch is too loose, rotate the latch strut anti-clockwise to lengthen the latch strut by 1/2 a turn.



Replace the frame latch detent pin as shown.



Unfold the frame as shown.



Close the frame latch as shown. The latch should begin to feel tight between 45mm and 55mm from the fully closed position. See Adjusting the Frame Latch.



Check the latch is closed.

**⚠ WARNING:** Ensure that the red latch lock is visible and engaged with the frame as shown. If the red latch lock is not visible as shown or is not engaged with the frame, do not ride the Gocycle. Contact your local Gocycle dealer or contact us through [gocycle.com/support](https://gocycle.com/support) for support. Failure to check the latch is locked may result in serious injury or death.





Push hard on the latch in the direction shown to confirm that the latch is locked. Check latches are locked. Latch should not open when pushed hard in direction shown.

 **WARNING:** Failure to check latch is locked may result in serious injury or death.



With the black latch closed and using only one finger, press and release the red latch lock multiple times.

- The black latch should not open and the red latch lock should remain engaged and “hooked/locked” into the frame or handlebar when released.
- The red latch lock should move freely with minimum force and it should spring back fast and sharply to the fully locked position.
- The red latch lock should not stick or squeak or freeze and it should not have a slow, partially closed or delayed action.



 **WARNING:** A Gocycle with fold latches that does not pass this important safety check poses a risk of injury and must not be ridden.



### 5.11 Maintenance and Cleaning of the Folding Hinges

Most folding bikes will have wear and tear within and around the folding hinges which includes paint coming off and wear at different points in around the hinge joint. During riding, acceleration, and braking, the hinge joint will flex and move which will cause the contact and interface points to move and fret dynamically and high surface pressure can occur. In the first 500 miles or 800 kms bedding in period wear and tear may be accelerated, for example where paint is worn or eroded away. Marking could occur immediately on folding and unfolding the product. This is considered normal and cosmetic on a subprime surface and does not affect the structural integrity of the G4.

Whilst not essential, the folding hinge interface areas and contact points should be maintained in order to prevent accelerated wear of the joint contact points and excessive loss of paint or noise. Where the joint is not maintained, paint debris can build up and create more wear than normal.

We recommend that you clean and wipe down the wear areas every 80-160 kms or 50-100 miles and up until 500 miles. Check the joint from time to time when folding to determine if more frequent maintenance is required. If there are any areas of exposed metal there may be a minor amount of surface oxidation that will occur, but this will not affect the structural integrity of the hinge.

With regular maintenance any wear and tear should stabilize after 500 miles or 800 kms.

### 5.12 Adjusting the bearings on the Rear Hub

It is unlikely that you will need to adjust the bearings on the rear hub. However, in the event that the rear wheel develops play (more than 1mm at the rim) or it feels heavy to pedal (i.e. the hub is too tight), you may need to adjust the bearing cone.



**WARNING!** Check the hub gear bearing adjustment every 500 miles (800 km) or 3 months. Regular checks will ensure best possible performance for your Gocycle.

Failure to inspect the hub gear bearing adjustment may have serious consequences and could result in serious bodily injury or even death.



To check if adjustment is required, using gentle pressure, move the rear wheel at the rim side to side.

Some flex in the wheel is normal, but if you feel that the wheel is loose, you will need to adjust the bearing cone as shown below:



Loosen the five bolts holding the rear wheel in place.



Remove the hub cap.



Remove the PitstopWheel.

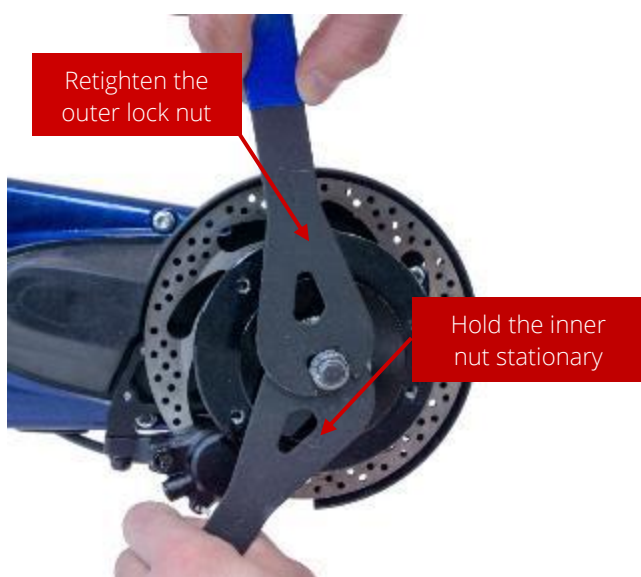
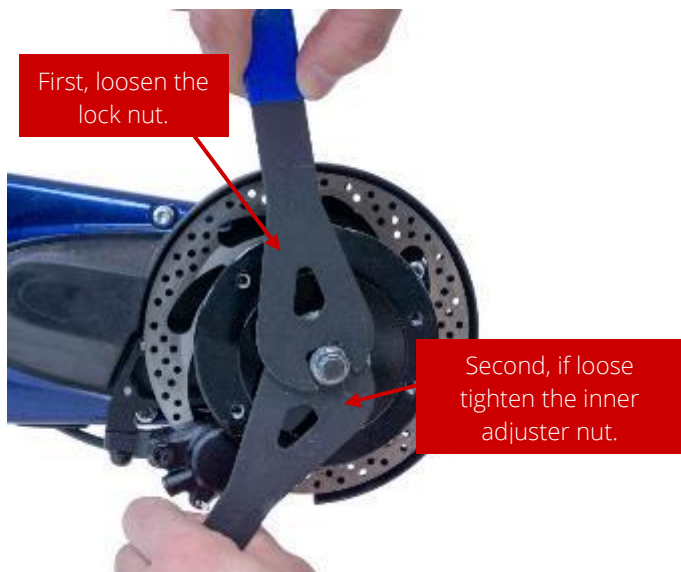

Using two 14mm cone adjustment spanners, adjust the rear hub gear bearing cone.

Between adjustments, check that the rear hub rotates in the freewheel direction. The bearing cup nuts should be tightened until the wheel does not have more than 1mm of “free” play at the rim when the PitstopWheel is attached, and the wheel is able to rotate freely. This is a matter of compromise and feel. If in doubt, consult your local Gocycle dealer or [Gocycle Tech Support](#) for advice.

Retighten the outer lock nut. Note: after tightening the outer lock nut, the hub may need re-adjusting due to the nature of the tightening process. You may need to repeat this process until you have the desired freeness of rotation and minimal lateral play at the rim.



## 6 TROUBLESHOOTING

### 6.1 Service and Inspection Reminder

*Symptom:*



*Resolution:* This is a reminder that a service or inspection is due.

**NOTE:** After 100 miles/160 kms and every further 500 miles/800 kms, the dash will alternatively flash 2 LEDs on the left and 2 LEDs on the right. This is an important safety reminder that a service or inspection is due. In the event that your dash is flashing the service reminder, please visit [www.gocycle.com/safety](http://www.gocycle.com/safety) and review any important Technical Bulletins and safety information relating to your Gocycle model. You should also download and review the latest Owner's Manual from [www.gocycle.com/manuals](http://www.gocycle.com/manuals). After visiting [www.gocycle.com/safety](http://www.gocycle.com/safety) you can dismiss the service reminder in the app to return the dash to normal display.

Note, by resetting the service reminder you are confirming that you have visited [www.gocycle.com/safety](http://www.gocycle.com/safety) and have understood any Technical Bulletins or new information relating to your Gocycle and you have downloaded and reviewed the Owner's Manual relating to your Gocycle.



## 6.2 Diagnosis Modes

The GocycleConnect® App has a number of diagnostics tools to assist you with troubleshooting. These tools can be accessed from the settings menu. In the event that you require technical assistance to diagnose an issue, contact your Gocycle reseller or contact us through [gocycle.com/support](https://gocycle.com/support) in order to assist you in using the tools available as shown below. See video here for further explanation: <https://vimeo.com/534382169>

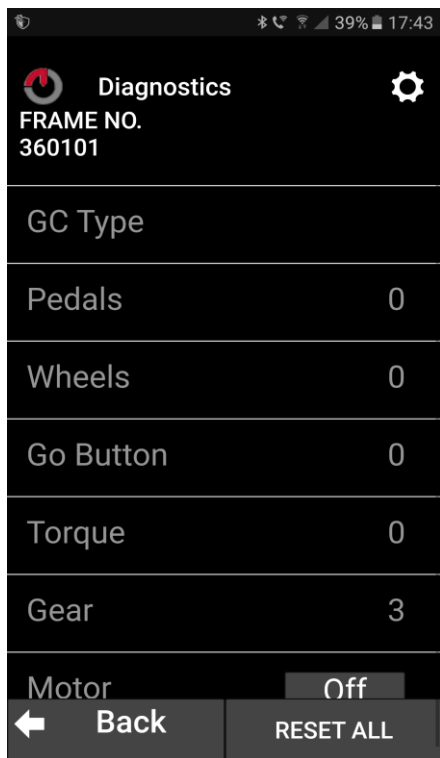

## 6.3 Log Upload

To assist with diagnosing and troubleshooting our support team may request for the Gocycle log to be uploaded. Uploading the log data will enable our Gocycle Tech Support team to analyse data from the sensors, motor controller, and settings on the Gocycle which could assist with fault diagnosis.

NB: The log data is not date/time stamped or location tracked.